



Secure Seal[®]

Single-Wall, Double-Wall and Double-Wall
Insulated Special Gas Vent



www.securitychimneys.com
800-361-4909 (US) 800-667-3387 (Canada)

Secure Seal® SS, SSD, SSID, & Flex

QUALITY AND DEPENDABILITY

The Secure Seal flue is manufactured from stainless steel designed for extreme resistance to chloride ion pitting, crevice corrosion and stress corrosion cracking, as well as general corrosion in oxidizing and moderately reducing environments. AL29-4C is the standard choice, but also available in 316L, for withstanding the harmful effects of corrosive condensates created by partially or fully condensing high-efficiency natural gas and propane-fired heating appliances.

The Canadian Gas Research Institute found that test results proved AL29-4C and 316L to be one of the two “most corrosion-resistant alloys of 20 candidate stainless steels evaluated for resistance to chloride-induced corrosion in condensing and partially condensing gas-fired appliances.”

STRINGENT STANDARDS FOR QUALITY ASSURANCE

To guarantee a perfect fit every time and to avoid built-in stress points or weak areas, tube ends are formed under stringent guidelines and held to exacting standards.

The casing (outer tube on Secure Seal SSD/SSID) is manufactured from type 441 stainless steel to provide long-lasting performance and stability when exposed to the outdoors.

The air space between the flue and casing is 1” on SSD and 2” insulated on SSID, providing close clearances to combustibles, reasonable outside dimensions and an additional heat shield or margin of safety where needed.

BUILT TO LAST

Secure Seal features a smooth weld seam inside and out, which is completely shielded during the welding process. Contamination or molecular changes in the weld seam are avoided and no fillers are used in the welding process.

The Secure Seal double-wall system is fully interchangeable with our Secure Seal single-wall system. Both have been conformed to UL1738 and certified to ULC-S636 safety standards. When installed according to Security Chimneys’ installation instructions, Secure Seal meets all test requirements for horizontal and vertical, interior or exterior installations. SSID features the same construction as SSD, but with 2” air space filled with mineral wool insulation.



SECURITY CHIMNEYS

SECURE SEAL

SINGLE WALL AND DOUBLE WALL GAS VENT



Features	Benefits
Laser butt-welding	<ul style="list-style-type: none"> • Reinforces strength • Prevents leakage • Increases durability and reliability
Built-in Secure Lock system	<ul style="list-style-type: none"> • Provides quick and easy assembly and disassembly • Requires less time on the job site
Secure Seal sealing gaskets	<ul style="list-style-type: none"> • Self-sealing, so there's no need to apply sealing material when pieces are joined together • Easier and faster installation
Standard adjustable vent length	<ul style="list-style-type: none"> • Provides vertical or horizontal adjustment for easy system pitching
AL29-4C stainless steel standard or 316L stainless steel alternative	<ul style="list-style-type: none"> • Resists the extreme corrosive environments found in condensing boilers • Assures safe and trouble-free operation
Proven track record	<ul style="list-style-type: none"> • Conformed to UL1738 and certified to ULC-S636 • Type L: Listed to UL-641 and ULC-S609 (SSD/SSID) • 15-year warranty
All accessories made of stainless steel	<ul style="list-style-type: none"> • For durability

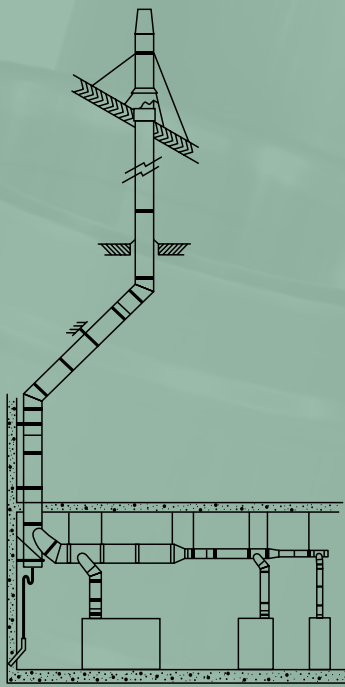

Secure Seal Single Wall (SS)
Vertical Installation



Secure Seal Double Wall (SSD)
Vertical Through-the-Roof Installation

Effective Length:

When assembling two parts together, the joint will overlap 2-3/8". So effective length is normal length minus 2-3/8".

Vertical Installation Requirements

1. The vent system must terminate at least 3 feet above the roof line and at least 2 feet higher than any portion of the building within 10 feet. This limitation can be removed if an engineering analysis demonstrates normal and safe operation of appliance.
2. When terminated at a height of more than 10 feet, the stack must be supported by a Guy Section.
3. The vent system must terminate with one of the Secure Seal terminations.

SECURE SEAL SINGLE WALL (SS)

Minimum Clearance to Combustibles

Diameter	Rated operating temperature	Max flue gas temperature	Enclosed		Unenclosed	
			Horizontal	Vertical	Horizontal	Vertical
3" to 12"	480° F	550° F	N/A	N/A	2"	2"
14" to 24"	480° F	550° F	N/A	N/A	4"	4"

SECURE SEAL DOUBLE WALL (SSD/SSID)

Minimum Clearance to Combustibles

Diameter	Rated operating temperature	Max flue gas temperature	Enclosed		Unenclosed	
			Horizontal	Vertical	Horizontal	Vertical
3" to 12"	480° F	550° F	N/A	1"	1"	1"
14" to 24"	480° F	550° F	N/A	1"	3"	1"
3" to 12" (L-Vent)	480° F	570° F	N/A	2"	2"	2"
14" to 24" (L-Vent)	480° F	570° F	N/A	2"	3"	2"

Material Thickness

Diameter	Inner Wall Material Thickness	Outer Wall Material Thickness
3" - 9"	AL29-4C - .015" 316L - .015"	AL29-4C - .015" 316L - .015"
10" - 16"	AL29-4C - .020" 316L - .019"	AL29-4C - .020" 316L - .019"
18" - 24"	AL29-4C - .024" 316L - .024"	AL29-4C - .024" 316L - .024"

PART NUMBERS

These instructions identify major model SS-SSD-SSID parts by name and part number.

Material Code Designations	
B	Type 316 Stainless Steel
H	Type 430 Stainless Steel
K	Type 441 Stainless Steel
P	Type 439 Stainless Steel
U	Type AL29-4C Stainless Steel

Example:

SSD 36" length with inside diameter 14" made of AL29-4C inner flue and SS441

outer casting.

SSD	14	L36	UK
Model	Dia.	Part	Material

SS 30° elbow with inside diameter 22"

made of 316L.

SS	22	E30	B
Model	Dia.	Part	Material

SSD wall support for 8" diameter chimney

made of stainless 439.

SSD	8	WSHD	P
Model	Dia.	Part	Material

Installation

Each Secure Seal vent length and component features our Secure Lock system and Viton® o-ring gasket, which insure a gas- and water-tight system. Parts are easily pushed and fastened together instantly and effortlessly.

Secure Seal can be taken apart and easily reassembled, making inspection, maintenance or rerouting of Secure Seal systems simple and straightforward.

Secure Seal provides an extensive range of components and accessories, made of stainless steel, allowing any type of installation. On top of the common components, we also offer special parts that help simplify installation, such as the 2-degree elbow and 43-degree tee (simplifying pitching on a horizontal vent) or the 18" and 36" adjustable lengths (to help maximize ease of installation). Connecting the SSD to a heater is effortless with one of the many adaptors approved by heating appliance manufacturers. Heating equipment can be operated immediately upon completing a Secure Seal installation, as no cure time or cleanup is required.

Note: If viton caulking is used at the boiler adaptor or an adjustable length, there is a cure time of 24 hours.

When venting Category I, II, III, or IV appliances or type L vented appliances, Secure Seal must be used for the entire length of the system. Do not mix pipe, fittings, or joining methods from different manufacturers. Every vent system must be planned and installed for optimum performance and safety. The venting system must be free to expand and contract and must be supported in accordance with these instructions. (Check for unrestricted vent movement through walls, ceilings, and roof penetrations). Refer to the gas appliance manufacturer's instructions to determine venting requirements and limitations with respect to installation and use of the appliance. It is the responsibility of the installer to contact local building and fire officials concerning any installation restrictions and/or inspection requirements that may apply. Permits may be required before starting and installation.

- If required by the appliance manufacturer, a Drain Tee Cap must be located as close as possible to the appliance flue outlet. Depending on the arrangement of the vent, more than one drain may be required. Unless a Drain Tee Cap is supplied with the appliance, install a Secure Seal Drain Tee Cap.
- More than one Category II, III, or IV appliance may not be connected into the same vent system unless the appliance manufacturer specifically approved such a system and the appliance is designed for multiple venting.
- Secure Seal must not come in contact with plumbing or electrical systems.
- Maintain rated clearances to combustibles over the entire length of the vent system.
- Secure Seal shall not be routed into, through, or within any vent, such as an existing masonry or factory-built chimney that is connected to another appliance.

SSD & SSID Venting Lengths

SSD & SSID Lengths

Use to vent category II, III and IV appliances.

Ø	Effective Length	Product Code SSD	Product Code SSID
3" to 24"	6-5/8"	SSDØL9	SSIDØL9
3" to 24"	9-5/8"	SSDØL12	SSIDØL12
3" to 24"	15-5/8"	SSDØL18	SSIDØL18
3" to 24"	21-5/8"	SSDØL24	SSIDØL24
3" to 24"	33-5/8"	SSDØL36	SSIDØL36

Note: SSID 3", 9" and 24" not available.

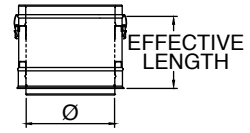

SSD & SSID Adjustable Lengths

Use to add length to straight length of Secure Seal pipe. Adds 2"–14" of length. Requires at least 4" overlap for a secure connection. Available in Custom Lengths.

Ø	Effective Length	Product Code SSD	Product Code SSID
3" to 24"	2" to 6-5/8"	SSDØAL9	SSIDØAL9
3" to 24"	2" to 15-5/8"	SSDØAL18	SSIDØAL18

Note: SSID 3", 9" and 24" not available.

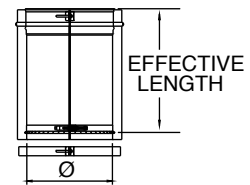

SSD & SSID Test Port Lengths

Use to test for proper appliance operation without penetrating the vent wall. Easy access to perform flue gas analysis. Test port plug included.

Ø	Effective Length	Product Code SSD	Product Code SSID
3" to 24"	6-5/8"	SSDØTPL	SSIDØTPL

Note: SSID 3", 9" and 24" not available.

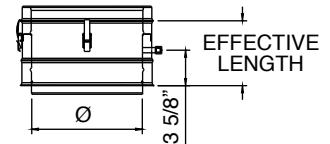

SSD & SSID Drain Lengths

Ø	Effective Length	Product Code SSD	Product Code SSID	K Factor
3" to 24"	6-5/8"	SSDØDL	SSIDØDL	0.25

Drain plug not included.
 Drain Ø4–Ø10, 1/4 NPT, 1/2 O.D.
 Drain 12–Ø24, 1/2 NPT, 5/8 O.D.
 Note: SSID 3", 9" and 24" not available.

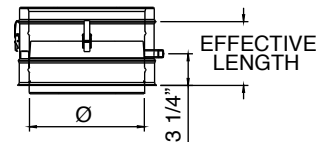

SSD & SSID Damper Lengths

Ø	Effective Length	Product Code SSD	Product Code SSID	K Factor
3" to 24"	21-5/8"	SSDØDAMP	SSIDØDAMP	0.60-9999

Note: SSID 3", 9" and 24" not available.

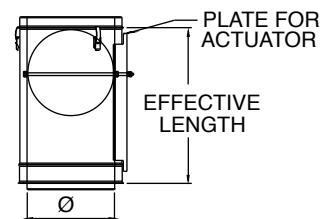

SSD & SSID Venting Lengths

SSD & SSID Damper Lengths Short

Ø	Effective Length	Product Code SSD	Product Code SSID	K Factor
3" to 24"	6-5/8"	SSDØDAMPS	SSIDØDAMPS	0 to 9999

Note: SSID 3", 9" and 24" not available.

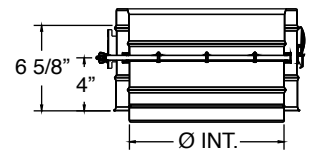

SSD K&W Fixed Blade Damper Lengths

Ø	Effective Length	Product Code SSD
6" to 18"	18"	SSDØKWDAMP

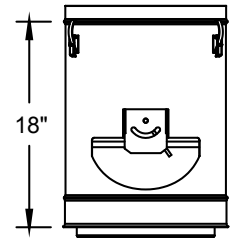

SSD Motorized Damper Lengths

Ø	Effective Length	Product Code SSD
3" to 18"	18"	SSDØMOTDAMP

Note: SSD 5", 7", 9", 11", 13", 15", and 17" not available.

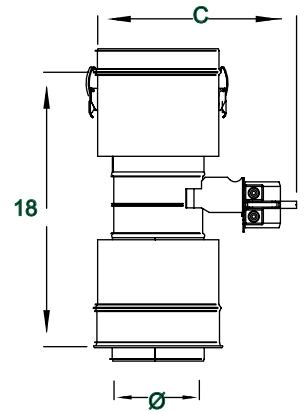

SSD & SSID Vent Flow Regulator

Ø	Effective Length	Product Code SSD	Product Code SSID	K Factor
3" to 24"	5-7/8"	SSDØVFR	SSIDØVFR	0 to 9999

Note: SSID 3", 9" and 24" not available.

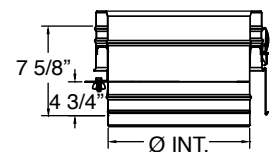

SSD Telescopic Lengths

Telescopic lengths do not require cutting to fit dimension.

Ø	Effective Length	Product Code
3" to 24"	14" to 20"	SSDØLAT20
3" to 24"	20" to 32"	SSDØLAT32

Note: SSID 3", 9" and 24" not available.

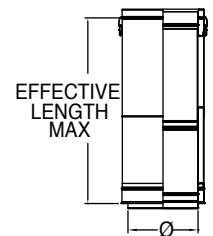

SSD & SSID Venting Elbows

SSD 2-Degree Elbow

Use to facilitate the 2° pitch required in horizontal runs. Offsets obstructions as needed. Allows for better condensate management and less back pressure.

Ø	Offset	Rise	Product Code SSD	K Factor
3" to 5"	1/8"	7-3/4"	SSDØE2	.04
6" to 8"	1/8"	7-7/8"	SSDØE2	.04
9" to 12"	1/8"	8"	SSDØE2	.04
14"	1/8"	8-1/8"	SSD14E2	.03
16" to 18"	1/8"	8-1/4"	SSDØE2	.03
20" to 22"	1/8"	8-3/8"	SSDØE2	.03
24"	1/8"	8-1/2"	SSD24E2	.03

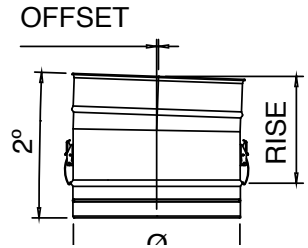

SSID 2-Degree Elbow

Use to facilitate the 2° pitch required in horizontal runs. Offsets obstructions as needed. Allows for better condensate management and less back pressure. 9" and 24" not available.

Ø	Offset	Rise	Product Code SSID	K Factor
4" to 5"	1/8"	7-3/4"	SSIDØE2	.04
6" to 8"	1/8"	7-7/8"	SSIDØE2	.04
10" to 12"	1/8"	8"	SSIDØE2	.04
14"	1/8"	8-1/8"	SSID14E2	.04
16" to 18"	1/8"	8-1/4"	SSIDØE2	.04
20" to 22"	1/8"	8-3/8"	SSIDØE2	.04

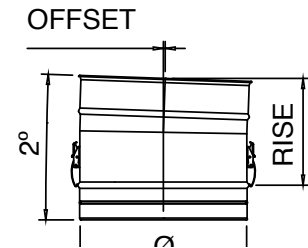

SSD 15-Degree Elbow

Offsets obstructions as needed. Allows for better condensate management and less back pressure.

Ø	Offset	Rise	Product Code SSD	K Factor
3"	1"	8-3/4"	SSD3E15	.31
4"	1"	8-3/4"	SSD4E15	.31
5"	1"	8-3/4"	SSD5E15	.30
6"	1-1/8"	9"	SSD6E15	.30
7"	1-1/8"	9-3/8"	SSD7E15	.29
8"	1-1/4"	9-5/8"	SSD8E15	.29
9"	1-1/4"	9-7/8"	SSD9E15	.28
10"	1-1/4"	10-1/8"	SSD10E15	.28
12"	1-3/8"	10-5/8"	SSD12E15	.27
14"	1-3/8"	11-1/8"	SSD14E15	.27
16"	1-1/2"	11-5/8"	SSD16E15	.26
18"	1-1/2"	12-1/8"	SSD18E15	.26
20"	1-5/8"	12-5/8"	SSD20E15	.26
22"	1-5/8"	13-1/4"	SSD22E15	.26
24"	1-3/4"	13-3/4"	SSD24E15	.26

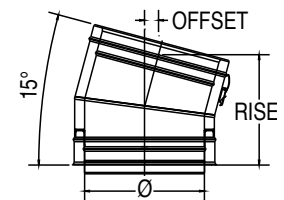

SSD & SSID Venting Elbows

SSID 15-Degree Elbow

Offsets obstructions as needed. Allows for better condensate management and less back pressure. 9" and 24" not available.

Ø	Offset	Rise	Product Code SSID	K Factor
4"	1-1/8"	9"	SSID4E15	.31
5"	1-1/8"	9-3/8"	SSID5E15	0.3
6"	1-1/4"	9-5/8"	SSID6E15	0.3
7"	1-1/4"	9-7/8"	SSID7E15	0.29
8"	1-1/4"	10-1/8"	SSID8E15	0.29
10"	1-3/8"	10-5/8"	SSID10E15	0.28
12"	1-3/8"	11-1/8"	SSID12E15	0.27
14"	1-1/2"	11-5/8"	SSID14E15	0.27
16"	1-1/2"	12-1/8"	SSID16E15	0.26
18"	1-5/8"	12-5/8"	SSID18E15	0.26
20"	1-5/8"	13-1/4"	SSID20E15	0.26
22"	1-3/4"	13-3/4"	SSID22E15	0.26

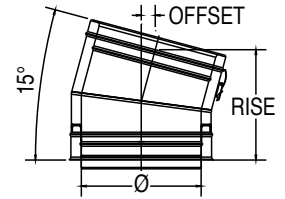

SSD 30-Degree Elbow

Offsets obstructions as needed. Allows for better condensate management and less back pressure.

Ø	Offset	Rise	Product Code SSD	K Factor
3"	2-3/8"	9-5/8"	SSD3E30	.65
4"	2-3/8"	9-5/8"	SSD4E30	.61
5"	2-3/8"	9-5/8"	SSD5E30	.60
6"	2-5/8"	10-1/8"	SSD6E30	.59
7"	2-3/4"	10-5/8"	SSD7E30	.58
8"	2-7/8"	11-1/8"	SSD8E30	.57
9"	3"	11-5/8"	SSD9E30	.56
10"	3-1/8"	12-1/8"	SSD10E30	.55
12"	3-3/8"	13-1/8"	SSD12E30	.54
14"	3-5/8"	14-1/8"	SSD14E30	.54
16"	3-7/8"	15-1/8"	SSD16E30	.53
18"	4-1/8"	16-1/8"	SSD18E30	.52
20"	4-1/2"	17-1/8"	SSD20E30	.52
22"	4-3/4"	18-1/8"	SSD22E30	.51
24"	5"	19-1/8"	SSD24E30	.51

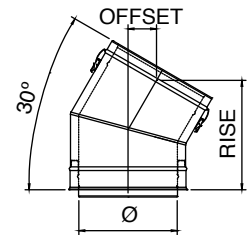

SSD & SSID Venting Elbows

SSID 30-Degree Elbow

Offsets obstructions as needed. Allows for better condensate management and less back pressure. 9" and 24" not available.

Ø	Offset	Rise	Product Code SSID	K Factor
4"	2-5/8"	10-1/8"	SSID4E30	0.61
5"	2-3/4"	10-5/8"	SSID5E30	0.60
6"	2-7/8"	11-1/8"	SSID6E30	0.59
7"	3"	11-5/8"	SSID7E30	0.58
8"	3-1/8"	12-1/8"	SSID8E30	0.57
10"	3-3/8"	13-1/8"	SSID10E30	0.55
12"	3-5/8"	14-1/8"	SSID12E30	0.54
14"	3-7/8"	15-1/8"	SSID14E30	0.54
16"	4-1/8"	16-1/8"	SSID16E30	0.53
18"	4-1/2"	17-1/8"	SSID18E30	0.52
20"	4-3/4"	18-1/8"	SSID20E30	0.52
22"	5"	19-1/8"	SSID22E30	0.51

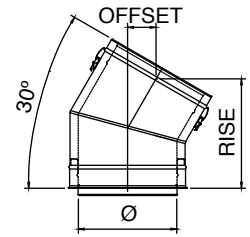

SSD 45-Degree Elbow

Offsets obstructions as needed. Allows for better condensate management and less back pressure.

Ø	Offset	Rise	Product Code SSD	K Factor
3"	3-7/8"	10-1/8"	SSD3E45	.30
4" to 5"	3-7/8"	10-1/8"	SSDØE45	.26
6"	4-1/4"	10-7/8"	SSD6E45	.17
7"	4-1/2"	11-1/2"	SSD7E45	.16
8"	4-7/8"	12-1/4"	SSD8E45	.14
9"	5-1/8"	13"	SSD9E45	.13
10"	5-3/8"	13-5/8"	SSD10E45	.12
12"	6"	15-1/8"	SSD12E45	.11
14"	6-5/8"	16-1/2"	SSD14E45	.11
16"	7-1/8"	17-7/8"	SSD16E45	.10
18"	7-3/4"	19-3/8"	SSD18E45	.09
20"	8-3/8"	20-3/4"	SSD20E45	.08
22"	8-7/8"	22-1/8"	SSD22E45	.08
24"	9-1/2"	23-5/8"	SSD24E45	.08

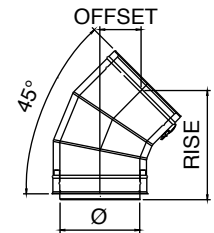

SSD & SSID Venting Elbows

SSID 45-Degree Elbow

Offsets obstructions as needed. Allows for better condensate management and less back pressure. 9" and 24" not available.

Ø	Offset	Rise	Product Code SSID	K Factor
4"	4-1/4"	10-7/8"	SSID4E45	0.26
5"	4-1/2"	11-1/2"	SSID5E45	0.22
6"	4-7/8"	12-1/4"	SSID6E45	0.17
7"	5-1/8"	13"	SSID7E45	0.16
8"	5-3/8"	13-5/8"	SSID8E45	0.14
10"	6"	15-1/8"	SSID10E45	0.12
12"	6-5/8"	16-1/2"	SSID12E45	0.11
14"	7-1/8"	17-7/8"	SSID14E45	0.11
16"	7-3/4"	19-3/8"	SSID16E45	0.1
18"	8-3/8"	20-3/4"	SSID18E45	0.09
20"	8-7/8"	22-1/8"	SSID20E45	0.08
22"	9-1/2"	23-5/8"	SSID22E45	0.08

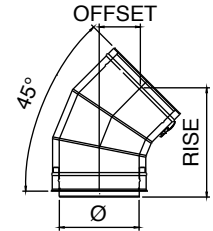

SSD 88-Degree Elbow

Use to transition from a vertical to a horizontal run. Stabilizes a 2° pitch towards the condensate drain for good condensate management.

Ø	Offset	Rise	Product Code SSD	K Factor
3"	8-3/8"	9-1/4"	SSD3E88	.60
4" to 5"	8-3/8"	9-1/4"	SSDØE88	.54
6"	9-1/4"	10-1/4"	SSD6E88	.42
7"	10-1/4"	11-1/4"	SSD7E88	.39
8"	11-1/4"	12-1/4"	SSD8E88	.37
9"	12-1/4"	13-1/4"	SSD9E88	.34
10"	13-1/8"	14-1/4"	SSD10E88	.32
12"	15-1/8"	16-1/4"	SSD12E88	.29
14"	17"	18-1/4"	SSD14E88	.27
16"	19"	20-1/4"	SSD16E88	.25
18"	20-7/8"	22-1/4"	SSD18E88	.24
20"	22-7/8"	24-1/4"	SSD20E88	.23
22"	24-3/4"	26-1/4"	SSD22E88	.21
24"	26-5/8"	28-1/4"	SSD24E88	.20

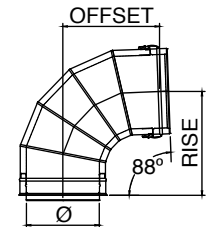

SSD & SSID Venting Elbows

SSID 88-Degree Elbow

Use to transition from a vertical to a horizontal run. Stabilizes a 2° pitch towards the condensate drain for good condensate management. 9" and 24" not available.

Ø	Offset	Rise	Product Code SSID	K Factor
4" to 5"	9"	9-1/4"	SSID0E88	.54
6"	9-1/4"	10-1/4"	SSID6E88	.42
7"	10-1/4"	11-1/4"	SSID7E88	.39
8"	11-1/4"	12-1/4"	SSID8E88	.37
10"	13-1/8"	14-1/4"	SSID10E88	.32
12"	15-1/8"	16-1/4"	SSID12E88	.29
14"	17"	18-1/4"	SSID14E88	.27
16"	19"	20-1/4"	SSID16E88	.25
18"	20-7/8"	22-1/4"	SSID18E88	.24
20"	22-7/8"	24-1/4"	SSID20E88	.23
22"	24-3/4"	26-1/4"	SSID22E88	.21

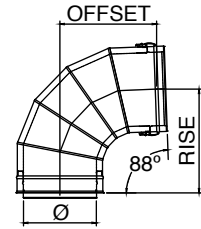

SSD 90-Degree Elbow

Use to go from horizontal to vertical runs or vertical to horizontal runs. Use to turn vent 90°.

Ø	Offset	Rise	Product Code SSD	K Factor
3"	8-1/2"	9-1/8"	SSD3E90	.60
4" to 5"	8-1/2"	9-1/8"	SSD0E90	.54
6"	9-1/2"	10-1/8"	SSD6E90	.42
7"	10-1/2"	11-1/8"	SSD7E90	.39
8"	11-1/2"	12-1/8"	SSD8E90	.37
9"	12-1/2"	13-1/8"	SSD9E90	.34
10"	13-1/2"	14-1/8"	SSD10E90	.32
12"	15-1/2"	16-1/8"	SSD12E90	.29
14"	17-1/2"	18-1/8"	SSD14E90	.27
16"	19-1/2"	20-1/8"	SSD16E90	.25
18"	21-1/2"	22-1/8"	SSD18E90	.24
20"	23-1/2"	24-1/8"	SSD20E90	.23
22"	25-1/2"	26-1/8"	SSD22E90	.21
24"	27-1/2"	28-1/8"	SSD24E90	.20

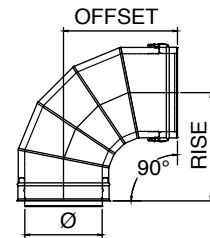

SSD & SSID Venting Elbows

SSID 90-Degree Elbow

Use to go from horizontal to vertical runs or vertical to horizontal runs. Use to turn vent 90°. 9" and 24" not available.

Ø	Offset	Rise	Product Code SSID	K Factor
4"	9-1/2"	10-1/8"	SSID4E90	0.54
5"	10-1/2"	11-1/8"	SSID5E90	0.48
6"	11-1/2"	12-1/8"	SSID6E90	0.42
7"	12-1/2"	13-1/8"	SSID7E90	0.39
8"	13-1/2"	14-1/8"	SSID8E90	0.37
10"	15-1/2"	16-1/8"	SSID10E90	0.32
12"	17-1/2"	18-1/8"	SSID12E90	0.29
14"	19-1/2"	20-1/8"	SSID14E90	0.27
16"	21-1/2"	22-1/8"	SSID16E90	0.25
18"	23-1/2"	24-1/8"	SSID18E90	0.24
20"	25-1/2"	26-1/8"	SSID20E90	0.23
22"	27-1/2"	28-1/8"	SSID22E90	0.21

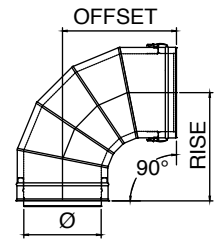

SSD & SSID Venting Tees

SSD 43-Degree Tee

Use in place of any tee for a 43° angle instead of 90°; can be used as a manifold connection to gang multiple boilers into a common vent.

Ø	Height	Offset	Rise	Product Code SSD	K Factor
3"	15-1/2"	7-5/8"	12-3/8"	SSD3T43	0.4
4"	16-1/2"	8-1/4"	13-3/8"	SSD4T43	0.4
5"	18-1/2"	8-7/8"	14-3/8"	SSD5T43	0.4
6"	19-1/2"	9-5/8"	15-3/8"	SSD6T43	0.4
7"	20-1/2"	10-1/4"	16-1/4"	SSD7T43	0.4
8"	22-1/2"	11-5/8"	18"	SSD8T43	0.4
9"	23-1/2"	12-1/4"	18-7/8"	SSD9T43	0.4
10"	25-1/2"	13"	19-3/4"	SSD10T43	0.4
12"	28-1/2"	15"	22-3/8"	SSD12T43	0.4
14"	31-1/2"	16-3/8"	24-1/4"	SSD14T43	0.4
16"	33-1/2"	18-1/2"	26-1/4"	SSD16T43	0.4
18"	38-1/4"	20-1/2"	29-3/8"	SSD18T43	0.4
20"	42-1/4"	23-7/8"	33-1/2"	SSD20T43	0.4
22"	45-1/4"	23-7/8"	33-7/8"	SSD22T43	0.4
24"	51-1/4"	27-7/8"	38-1/2"	SSD24T43	0.4

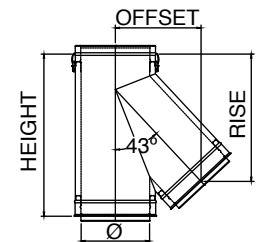

Available with smaller snout and custom height.

SSD & SSID Venting Tees

SSID 43-Degree Tee

Use in place of any tee for a 43° angle instead of 90°; can be used as a manifold connection to gang multiple boilers into a common vent. 9" and 24" not available.

Ø	Height	Offset	Rise	Product Code SSID	K Factor
4"	19-1/2"	9-5/8"	15-3/8"	SSID4T43	0.4
5"	20-1/2"	10-1/4"	16-1/4"	SSID5T43	0.4
6"	22-1/2"	11-5/8"	18"	SSID6T43	0.4
7"	23-1/2"	12-1/4"	18-7/8"	SSID7T43	0.4
8"	25-1/2"	13"	19-3/4"	SSID8T43	0.4
10"	28-1/2"	15"	22-3/8"	SSID10T43	0.4
12"	31-1/2"	16-3/8"	24-1/4"	SSID12T43	0.4
14"	33-1/2"	18-1/2"	26-1/4"	SSID14T43	0.4
16"	38-1/4"	20-1/2"	29-3/8"	SSID16T43	0.4
18"	42-1/4"	23-7/8"	33-1/2"	SSID18T43	0.4
20"	45-1/4"	23-7/8"	33-7/8"	SSID20T43	0.4
22"	51-1/4"	27-7/8"	38-1/2"	SSID22T43	0.4

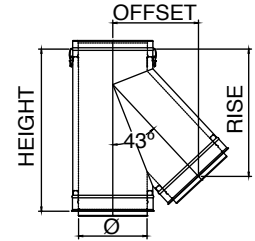

Available with smaller snout and custom height.

SSD 45-Degree Tee

Use in place of any tee for a 45° angle instead of 90°; can be used as a manifold connection to gang multiple boilers into a common vent.

Ø	Height	Offset	Rise	Product Code SSD	K Factor
3"	15-1/2"	7-5/8"	12-1/4"	SSD3T45	0.4
4"	16-1/2"	8-1/2"	13-1/4"	SSD4T45	0.4
5"	18-1/2"	9-1/4"	14-1/8"	SSD5T45	0.4
6"	19-1/2"	9-7/8"	15-1/8"	SSD6T45	0.4
7"	20-1/2"	10-5/8"	16"	SSD7T45	0.4
8"	22-1/2"	12"	17-5/8"	SSD8T45	0.4
9"	23-1/2"	12-3/4"	18-1/2"	SSD9T45	0.4
10"	25-1/2"	13-1/2"	19-1/2"	SSD10T45	0.4
12"	28-1/2"	15-5/8"	22"	SSD12T45	0.4
14"	31-1/2"	17"	23-7/8"	SSD14T45	0.4
16"	33-1/2"	19-1/8"	26-3/8"	SSD16T45	0.4
18"	38-1/4"	21-1/4"	28-7/8"	SSD18T45	0.4
20"	42-1/4"	24-3/4"	32-7/8"	SSD20T45	0.4
22"	45-1/4"	24-3/4"	33-1/4"	SSD22T45	0.4
24"	51-1/4"	28-7/8"	37-3/4"	SSD24T45	0.4

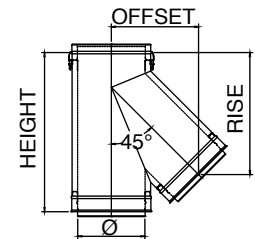

Available with smaller snout and custom height.

SSD & SSID Venting Tees

SSID 45-Degree Tee

Use in place of any tee for a 45° angle instead of 90°; can be used as a manifold connection to gang multiple boilers into a common vent. 9" and 24" not available.

Ø	Height	Offset	Rise	Product Code SSID	K Factor
4"	19-1/2"	9-7/8"	14-1/8"	SSID4T45	0.4
5"	20-1/2"	10-5/8"	14-1/8"	SSID5T45	0.4
6"	22-1/2"	12"	15-1/8"	SSID6T45	0.4
7"	23-1/2"	12-3/4"	16"	SSID7T45	0.4
8"	25-1/2"	13-1/2"	17-5/8"	SSID8T45	0.4
10"	28-1/2"	15-5/8"	19-1/2"	SSID10T45	0.4
12"	31-1/2"	17"	22"	SSID12T45	0.4
14"	33-1/2"	19-1/8"	23-7/8"	SSID14T45	0.4
16"	38-1/4"	21-1/4"	26-3/8"	SSID16T45	0.4
18"	42-1/4"	24-3/4"	28-7/8"	SSID18T45	0.4
20"	45-1/4"	24-3/4"	32-7/8"	SSID20T45	0.4
22"	51-1/4"	28-7/8"	33-1/4"	SSID22T45	0.4

Available with smaller snout and custom height.

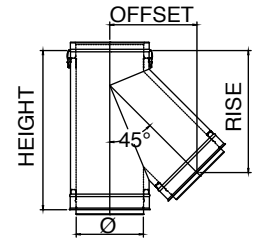

SSD 88-Degree Tee

Use for a 88° offset, or to combine connections from two or more appliances into a common vent. Can also use as a condensate management point when used in conjunction with drain fitting. All Standard Tees are completely welded.

Ø	Height	Offset	Rise	Product Code SSD	K Factor
3"	12-1/2"	7"	6-1/4"	SSD3T88	1.21
4"	13-1/2"	7"	6-5/8"	SSD4T88	1.21
5"	14-1/2"	8"	7-1/4"	SSD5T88	1.21
6"	15-1/2"	8"	7-5/8"	SSD6T88	1.21
7"	16-1/2"	9"	8-1/4"	SSD7T88	1.21
8"	17-1/2"	9"	8-5/8"	SSD8T88	1.21
9"	18-1/2"	10"	9-1/4"	SSD9T88	1.21
10"	19-1/2"	10"	9-5/8"	SSD10T88	1.21
12"	21-1/2"	11"	10-5/8"	SSD12T88	1.21
14"	23-1/2"	12"	11-5/8"	SSD14T88	1.21
16"	25-1/2"	13"	12-5/8"	SSD16T88	1.21
18"	27-1/2"	14"	13-5/8"	SSD18T88	1.21
20"	29-1/2"	15"	14-5/8"	SSD20T88	1.21
22"	31-1/2"	16"	15-5/8"	SSD22T88	1.21
24"	33-1/2"	17"	16-5/8"	SSD24T88	1.21

Available with smaller snout and custom height.

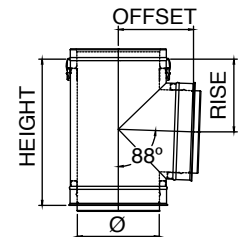

SSD & SSID Venting Tees

SSID 88-Degree Tee

Use for a 88° offset, or to combine connections from two or more appliances into a common vent. Can also use as a condensate management point when used in conjunction with drain fitting. All Standard Tees are completely welded. 9" and 24" not available.

Ø	Height	Offset	Rise	Product Code SSID	K Factor
4"	15-1/2"	8"	7-5/8"	SSID4T88	1.21
5"	16-1/2"	9"	8-1/4"	SSID5T88	1.21
6"	17-1/2"	9"	8-5/8"	SSID6T88	1.21
7"	18-1/2"	10"	9-1/4"	SSID7T88	1.21
8"	19-1/2"	10"	9-5/8"	SSID8T88	1.21
10"	21-1/2"	11"	10-5/8"	SSID10T88	1.21
12"	23-1/2"	12"	11-5/8"	SSID12T88	1.21
14"	25-1/2"	13"	12-5/8"	SSID14T88	1.21
16"	27-1/2"	14"	13-5/8"	SSID16T88	1.21
18"	29-1/2"	15"	14-5/8"	SSID18T88	1.21
20"	31-1/2"	16"	15-5/8"	SSID20T88	1.21
22"	33-1/2"	17"	16-5/8"	SSID22T88	1.21

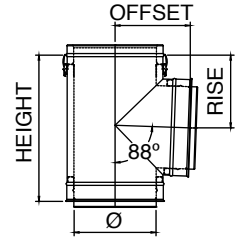

Available with smaller snout and custom height.

SSD 90-Degree Tee

Use for a 90° offset, or to combine connections from two or more appliances into a common vent. Can also use as a condensate management point when used in conjunction with drain fitting. All Standard Tees are completely welded.

Ø	Height	Offset	Rise	Product Code SSD	K Factor
3"	12-1/2"	7"	6-1/4"	SSD3T90	1.21
4"	13-1/2"	7"	6-1/2"	SSD4T90	1.21
5"	14-1/2"	8"	7"	SSD5T90	1.21
6"	15-1/2"	8"	7-1/2"	SSD6T90	1.21
7"	16-1/2"	9"	8"	SSD7T90	1.21
8"	17-1/2"	9"	8-1/2"	SSD8T90	1.21
9"	18-1/2"	10"	9"	SSD9T90	1.21
10"	19-1/2"	10"	9-1/2"	SSD10T90	1.21
12"	21-1/2"	11"	10-1/2"	SSD12T90	1.21
14"	23-1/2"	12"	11-1/2"	SSD14T90	1.21
16"	25-1/2"	13"	12-1/2"	SSD16T90	1.21
18"	27-1/2"	14"	13-1/2"	SSD18T90	1.21
20"	29-1/2"	15"	14-1/2"	SSD20T90	1.21
22"	31-1/2"	16"	15-1/2"	SSD22T90	1.21
24"	33-1/2"	17"	16-1/2"	SSD24T90	1.21

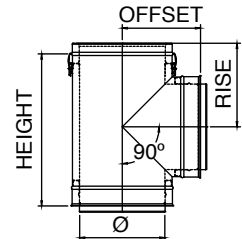

Available with smaller snout and custom height.

SSD & SSID Venting Tees

SSID 90-Degree Tee

Use for a 90° offset, or to combine connections from two or more appliances into a common vent. Can also use as a condensate management point when used in conjunction with drain fitting. All Standard Tees are completely welded. 9" and 24" not available.

Ø	Height	Offset	Rise	Product Code SSID	K Factor
4"	15-1/2"	8"	7-1/2"	SSID4T90	1.21
5"	16-1/2"	9"	8"	SSID5T90	1.21
6"	17-1/2"	9"	8-1/2"	SSID6T90	1.21
7"	18-1/2"	10"	9"	SSID7T90	1.21
8"	19-1/2"	10"	9-1/2"	SSID8T90	1.21
10"	21-1/2"	11"	10-1/2"	SSID10T90	1.21
12"	23-1/2"	12"	11-1/2"	SSID12T90	1.21
14"	25-1/2"	13"	12-1/2"	SSID14T90	1.21
16"	27-1/2"	14"	13-1/2"	SSID16T90	1.21
18"	29-1/2"	15"	14-1/2"	SSID18T90	1.21
20"	31-1/2"	16"	15-1/2"	SSID20T90	1.21
22"	33-1/2"	17"	16-1/2"	SSID22T90	1.21

Available with smaller snout and custom height.

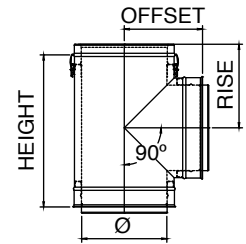

SSD 90-Degree Tee Y

Ø	Offset	Rise	Product Code SSD	K Factor
3"	4.5"	9-5/8"	SSD3TY90	0.6
4"	5"	10-3/8"	SSD4TY90	0.6
5" and 6"	5-5/8"	11-1/8"	SSDØTY90	0.6
7" and 8"	6-3/8"	11-3/4"	SSDØTY90	0.6
9" and 10"	7-1/8"	13-1/2"	SSDØTY90	0.6
12"	7-3/4"	14-1/4"	SSD12TY90	0.6
14"	8-1/2"	15-7/8"	SSD14TY90	0.6
16"	9-1/4"	17-5/8"	SSD16TY90	0.6
18"	9-7/8"	18-3/8"	SSD18TY90	0.6
20"	10-5/8"	21"	SSD20TY90	0.6
22"	11-3/8"	21-3/4"	SSD22TY90	0.6
24"	12"	22-1/2"	SSD24TY90	0.6

Available with smaller snout.

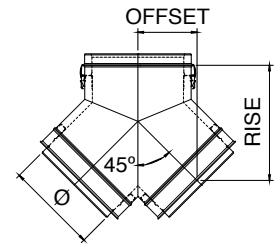

SSD & SSID Venting Tees

SSID 90-Degree Tee Y

Ø	Offset	Rise	Product Code SSID	K Factor
4"	5-5/8"	11-1/8"	SSID4TY90	0.6
5" to 6"	6-3/8"	11-3/4"	SSIDØTY90	0.6
7" to 8"	7-1/8"	13-1/2"	SSIDØTY90	0.6
10"	7-3/4"	14-1/4"	SSID10TY90	0.6
12"	8-1/2"	15-7/8"	SSID12TY90	0.6
14"	9-1/4"	17-5/8"	SSID14TY90	0.6
16"	9-7/8"	18-3/8"	SSID16TY90	0.6
18"	10-5/8"	21"	SSID18TY90	0.6
20"	11-3/8"	21-3/4"	SSID20TY90	0.6
22"	12"	22-1/2"	SSID22TY90	0.6

Available with smaller snout. 9" and 24" not available.

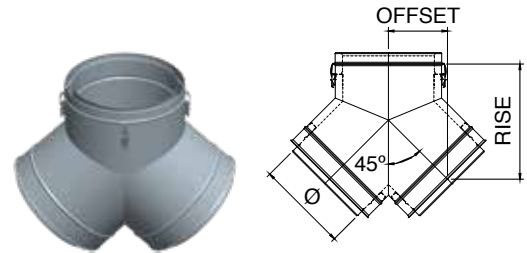

SSD Lateral SecureTEE

Use to transition from horizontal to vertical with improved flue gas flow.

Ø	Height	Offset	Rise	Product Code SSD	K Factor
3"	13-3/8"	11-1/8"	9"	SSD3BT	0.55
4"	14-3/8"	11-5/8"	10"	SSD4BT	0.55
5"	16-3/8"	12-1/4"	11"	SSD5BT	0.55
6"	17-3/8"	13-3/4"	12-1/4"	SSD6BT	0.55
7"	19-3/8"	14-3/4"	13-1/4"	SSD7BT	0.55
8"	20-3/8"	16"	14-3/8"	SSD8BT	0.55
9"	23-3/8"	14-1/4"	14-1/4"	SSD9BT	0.55
10"	25-3/8"	15-1/4"	15-1/4"	SSD10BT	0.55
12"	27-3/8"	16-7/8"	17"	SSD12BT	0.55
14"	30-3/8"	18-7/8"	18-7/8"	SSD14BT	0.55
16"	33-3/8"	20-3/4"	20-3/4"	SSD16BT	0.55
18"	38-1/8"	22-1/2"	22-1/2"	SSD18BT	0.55
20"	42-1/8"	24-3/4"	24-3/8"	SSD20BT	0.55
22"	45-1/8"	26-1/4"	26-1/4"	SSD22BT	0.55
24"	51-1/8"	28"	28-1/8"	SSD24BT	0.55

Available with smaller snout and custom height.

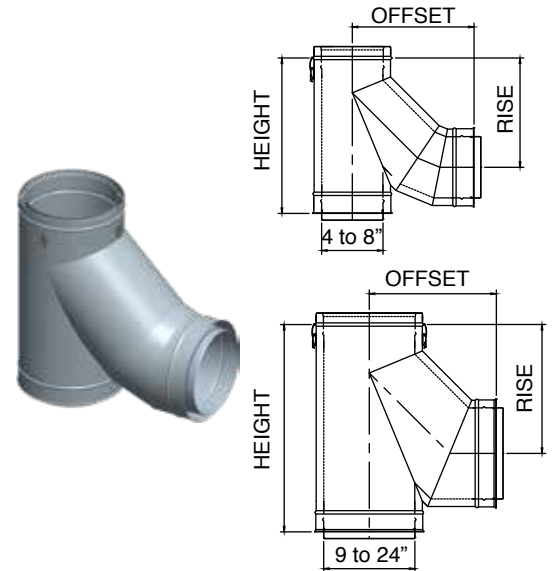

SSD & SSID Venting Tees

SSID Lateral SecureTEE

Use to transition from horizontal to vertical with improved flue gas flow. 9" and 24" not available.

Ø	Height	Offset	Rise	Product Code SSID	K Factor
4"	17-3/8"	13-3/4"	12-1/4"	SSID4BT	0.55
5"	19-3/8"	14-3/4"	13-1/4"	SSID5BT	0.55
6"	20-3/8"	16"	14-3/8"	SSID6BT	0.55
7"	23-3/8"	14-1/4"	14-1/4"	SSID7BT	0.55
8"	25-3/8"	15-1/4"	15-1/4"	SSID8BT	0.55
10"	27-3/8"	16-7/8"	17"	SSID10BT	0.55
12"	30-3/8"	18-7/8"	18-7/8"	SSID12BT	0.55
14"	33-3/8"	20-3/4"	20-3/4"	SSID14BT	0.55
16"	38-1/8"	22-1/2"	22-1/2"	SSID16BT	0.55
18"	42-1/8"	24-3/4"	24-3/8"	SSID18BT	0.55
20"	45-1/8"	26-1/4"	26-1/4"	SSID20BT	0.55
22"	51-1/8"	28"	28-1/8"	SSID22BT	0.55

Available with smaller snout and custom height.

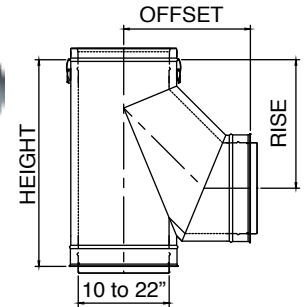
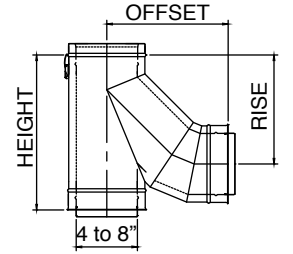

SSD Lateral SecureTEE 88-Degree

Use to transition from horizontal to vertical with improved flue gas flow.

Ø	Height	Offset	Rise	Product Code SSD	K Factor
3"	13-3/8"	11-1/8"	9"	SSD3BT88	0.55
4"	14-3/8"	11-5/8"	10-1/4"	SSD4BT88	0.55
5"	16-3/8"	12-1/4"	11-3/8"	SSD5BT88	0.55
6"	17-3/8"	13-3/4"	12-3/4"	SSD6BT88	0.55
7"	19-3/8"	14-7/8"	13-3/4"	SSD7BT88	0.55
8"	20-3/8"	16-1/8"	15"	SSD8BT88	0.55
9"	23-3/8"	14-1/2"	15-1/4"	SSD9BT88	0.55
10"	25-3/8"	15-3/8"	16-1/8"	SSD10BT88	0.55
12"	28-3/8"	17"	17-7/8"	SSD12BT88	0.55
14"	31-3/8"	19-1/8"	20-1/8"	SSD14BT88	0.55
16"	33-3/8"	21"	22"	SSD16BT88	0.55
18"	38-3/8"	22-7/8"	24"	SSD18BT88	0.55
20"	42-1/8"	24-3/4"	26"	SSD20BT88	0.55
22"	45-1/8"	26-5/8"	28"	SSD22BT88	0.55
24"	51-1/8"	28-1/2"	29-7/8"	SSD24BT88	0.55

Available with smaller snout and custom height.

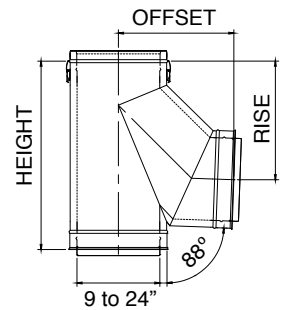
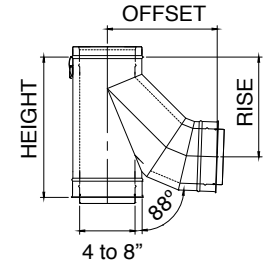

SSD & SSID Venting Tees

SSD Lateral SecureTEE 88-Degree

Use to transition from horizontal to vertical with improved flue gas flow. 9" and 24" not available.

Ø	Height	Offset	Rise	Product Code SSID	K Factor
4"	17-3/8"	13-3/4"	12-3/4"	SSID4BT88	0.55
5"	19-3/8"	14-7/8"	13-3/4"	SSID5BT88	0.55
6"	20-3/8"	16-1/8"	15"	SSID6BT88	0.55
7"	23-3/8"	14-1/2"	15-1/4"	SSID7BT88	0.55
8"	25-3/8"	15-3/8"	16-1/8"	SSID8BT88	0.55
10"	28-3/8"	17"	17-7/8"	SSID10BT88	0.55
12"	31-3/8"	19-1/8"	20-1/8"	SSID12BT88	0.55
14"	33-3/8"	21"	22"	SSID14BT88	0.55
16"	38-3/8"	22-7/8"	24"	SSID16BT88	0.55
18"	42-1/8"	24-3/4"	26"	SSID18BT88	0.55
20"	45-1/8"	26-5/8"	28"	SSID20BT88	0.55
22"	51-1/8"	28-1/2"	29-7/8"	SSID22BT88	0.55

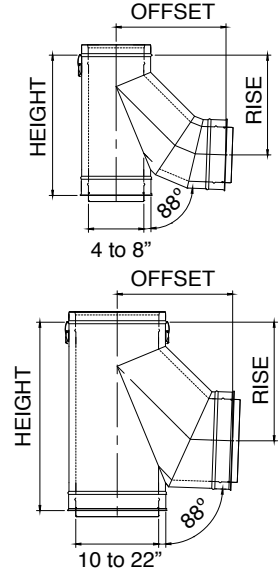

SSD Barometric Tee

Ø	Height	Offset	Rise	Product Code SSD	K Factor
3"	12-1/2"	8"	6"	SSD3BMT	0.2
4"	13-1/2"	8"	6-1/2"	SSD4BMT	0.2
5"	14-1/2"	9"	7"	SSD5BMT	0.2
6"	15-1/2"	9"	7-1/2"	SSD6BMT	0.2
7"	16-1/2"	10"	8"	SSD7BMT	0.2
8"	17-1/2"	10"	8-1/2"	SSD8BMT	0.2
9"	18-1/2"	11"	9"	SSD9BMT	0.2
10"	19-1/2"	11"	9-1/2"	SSD10BMT	0.2
12"	21-1/2"	12"	10-1/2"	SSD12BMT	0.2
14"	23-1/2"	13"	11-1/2"	SSD14BMT	0.2
16"	25-1/2"	14"	12-1/2"	SSD16BMT	0.2
18"	27-1/2"	15"	13-1/2"	SSD18BMT	0.2
20"	29-1/2"	16"	14-1/2"	SSD20BMT	0.2
22"	31-1/2"	17"	15-1/2"	SSD22BMT	0.2
24"	33-1/2"	18"	16-1/2"	SSD24BMT	0.2

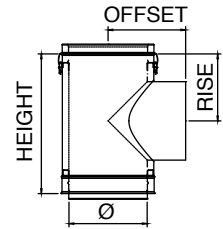

Available with smaller snout and custom height.

SSD & SSID Venting Tees

SSID Barometric Tee

Ø	Height	Offset	Rise	Product Code SSD	K Factor
4"	15-1/2"	9"	7-1/2"	SSID4BMT	0.2
5"	16-1/2"	10"	8"	SSID5BMT	0.2
6"	17-1/2"	10"	8-1/2"	SSID6BMT	0.2
7"	18-1/2"	11"	9"	SSID7BMT	0.2
8"	19-1/2"	11"	9-1/2"	SSID8BMT	0.2
10"	21-1/2"	12"	10-1/2"	SSID10BMT	0.2
12"	23-1/2"	13"	11-1/2"	SSID12BMT	0.2
14"	25-1/2"	14"	12-1/2"	SSID14BMT	0.2
16"	27-1/2"	15"	13-1/2"	SSID16BMT	0.2
18"	29-1/2"	16"	14-1/2"	SSID18BMT	0.2
20"	31-1/2"	17"	15-1/2"	SSID20BMT	0.2
22"	33-1/2"	18"	16-1/2"	SSID22BMT	0.2

Available with smaller snout and custom height. 9" and 24" not available.

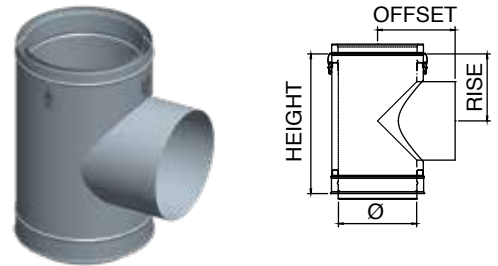

SSD & SSID Venting Accessories

SSD & SSID Tee Cap

Use to cap Standard Tee, Branch Tee or Boot Tee. Remove Tee Cap to inspect the system; clean out debris or collected condensate.

Ø	Height	Product Code SSD	Product Code SSID
3" to 24"	4-1/8"	SSDØTC	SSIDØTC

Note: SSID 3", 9" and 24" not available.

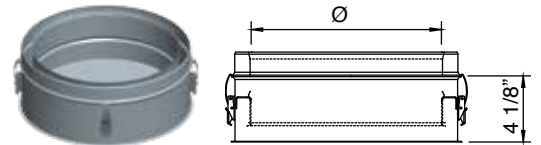

SSD & SSID Drain Tee Cap

Ø	Height	Product Code SSD	Product Code SSID
3" to 24"	4-1/8"	SSDØDTC	SSIDØDTC

Drain plug not included.
 Drain Ø4 – Ø10, 1/4 NPT, 1/2 O.D.
 Drain Ø12 – Ø24, 3/8 NPT, 5/8 O.D.
 Note: SSID 3", 9" and 24" not available.

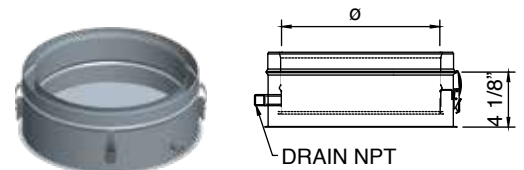

SSD & SSID Barometric Tee Cap

Ø	Height	Product Code SSD	Product Code SSID
3" to 24"	3-1/2"	SSDØBMTC	SSIDØBMTC



SSD & SSID Venting Accessories

SSD & SSID Tapered Inserter

Use to increase vent diameter. Creates a smooth transition for an undistruptive flow. Available in custom size combinations.

Ø	ØB Available	Height	Product Code SSD	Product Code SSID	K Factor
3" to 9"	Ø+1"	12-7/16"	SSDØTIN(ØB)	SSIDØTIN(ØB)	0.05
4" to 22"	Ø+2"	13-7/16"	SSDØTIN(ØB)	SSIDØTIN(ØB)	0.10
4" to 9"	Ø+3"	14-7/16"	SSDØTIN(ØB)	SSIDØTIN(ØB)	0.15
4" to 20"	Ø+4"	15-7/16"	SSDØTIN(ØB)	SSIDØTIN(ØB)	0.20
4" to 7"	Ø+5"	16-7/16"	SSDØTIN(ØB)	SSIDØTIN(ØB)	0.25
4" to 18"	Ø+6"	17-7/16"	SSDØTIN(ØB)	SSIDØTIN(ØB)	0.30

Note: SSID 9" and 24" not available.

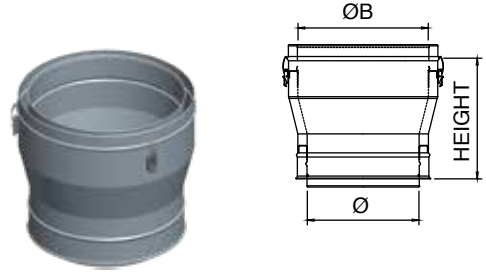

SSD & SSID Step Inserter

Use to increase vent diameter when space constraints are an issue. Available in custom size combinations.

Ø	ØB Available	Height	Product Code SSD	Product Code SSID	K Factor
3" to 22"	5" to 24"	8"	SSDØSIN(ØB)	SSIDØSIN(ØB)	$K\delta = (1 - \delta)^2$ $K\delta B = K\delta / 4$ $= \delta / \delta B$

Note: SSID 3", 9" and 24" not available.

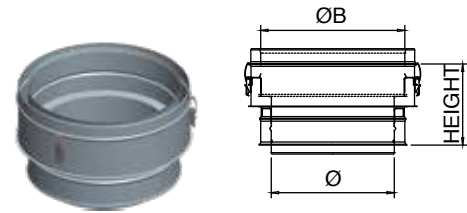

SSD & SSID Eccentric Tapered Inserter

Use to transition to a larger diameter pipe. Prevents condensate puddling when used on horizontal runs. Aids in reducing formation of condensates. Maximum 10" difference between diameter increase size on both sizes. Available in custom size combinations.

Ø	ØB Available	Height	Offset	Product Code SSD	Product Code SSID	K Factor
3" to 9"	Ø+1"	12-1/2"	1/2"	SSDØETIN(ØB)	SSIDØETIN(ØB)	0.05
4" to 22"	Ø+2"	13-1/2"	1"	SSDØETIN(ØB)	SSIDØETIN(ØB)	0.10
4" to 9"	Ø+3"	14-1/2"	1-1/2"	SSDØETIN(ØB)	SSIDØETIN(ØB)	0.15
4" to 20"	Ø+4"	15-1/2"	2"	SSDØETIN(ØB)	SSIDØETIN(ØB)	0.20
4" to 7"	Ø+5"	16-1/2"	2-1/2"	SSDØETIN(ØB)	SSIDØETIN(ØB)	0.25
4" to 18"	Ø+6"	17-1/2"	3"	SSDØETIN(ØB)	SSIDØETIN(ØB)	0.30

Note: SSID 3", 9" and 24" not available.

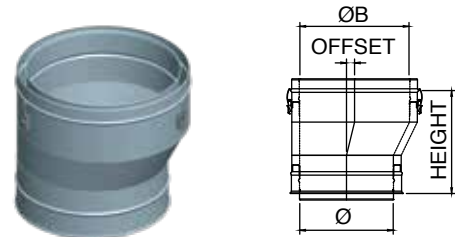

SSD & SSID Venting Accessories

SSD & SSID Eccentric Step Increaser

Ø	ØB Available	Height	Offset	Product Code SSD	Product Code SSID	K Factor
3" to 22"	5" to 24"	8"	$(\text{ØB}-\text{Ø})/2$	SSDØESIN(ØB)	SSIDØESIN(ØB)	$K\text{Ø}=(1-2)^2$ $K\text{ØB}=K\text{Ø}^4$ $=\text{Ø}/\text{ØB}$

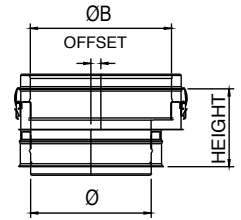

Note: SSID 3", 9" and 24" not available.

SSD & SSID Tapered Reducer

Ø	ØB Available	Height	Product Code SSD	Product Code SSID	K Factor
5" to 10"	Ø-1"	12-7/16"	SSDØTRD(ØB)	SSIDØTRD(ØB)	0.07
6" to 24"	Ø-2"	13-7/16"	SSDØTRD(ØB)	SSIDØTRD(ØB)	0.09
6" to 12"	Ø-3"	14-7/16"	SSDØTRD(ØB)	SSIDØTRD(ØB)	0.11
8" to 24"	Ø-4"	15-7/16"	SSDØTRD(ØB)	SSIDØTRD(ØB)	0.13
9" to 24"	Ø-5"	16-7/16"	SSDØTRD(ØB)	SSIDØTRD(ØB)	0.15
10" to 24"	Ø-6"	17-7/16"	SSDØTRD(ØB)	SSIDØTRD(ØB)	0.17

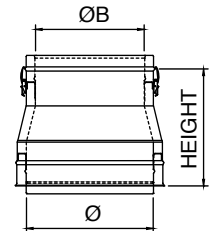

Note: SSID 9" and 24" not available.

SSD & SSID Step Reducer

Ø	ØB Available	Height	Product Code SSD	Product Code SSID	K Factor
5" to 24"	4" to 22"	8"	SSDØSRD(ØB)	SSIDØSRD(ØB)	$K\text{ØB}=0.5(1-2)^2$ $K\text{Ø}=K\text{ØB}^4=\text{ØB}/\text{Ø}$

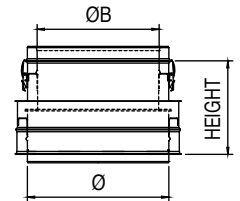

Note: SSID 9" and 24" not available.

SSD & SSID Eccentric Tapered Reducer

Ø	ØB Available	Height	Offset	Product Code SSD	Product Code SSID	K Factor
5" to 10"	Ø-1"	12-1/2"	1/2"	SSDØETRD(ØB)	SSIDØETRD(ØB)	0.07
6" to 24"	Ø-2"	13-1/2"	1"	SSDØETRD(ØB)	SSIDØETRD(ØB)	0.09
6" to 12"	Ø-3"	14-1/2"	1-1/2"	SSDØETRD(ØB)	SSIDØETRD(ØB)	0.11
8" to 24"	Ø-4"	15-1/2"	2"	SSDØETRD(ØB)	SSIDØETRD(ØB)	0.13
9" to 24"	Ø-5"	16-1/2"	2-1/2"	SSDØETRD(ØB)	SSIDØETRD(ØB)	0.15
10" to 24"	Ø-6"	17-1/2"	3"	SSDØETRD(ØB)	SSIDØETRD(ØB)	0.17

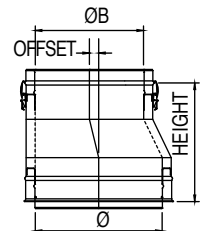

Note: SSID 9" and 24" not available.

SSD & SSID Venting Accessories

SSD & SSID Eccentric Step Reducer

Ø	ØB Available	Height	Offset
5" to 24"	4" to 22"	8"	$(\text{Ø}-\text{ØB})/2$

Product Code SSD	Product Code SSID	K Factor
SSDØESRD(ØB)	SSIDØESRD(ØB)	$K\text{ØB} = 0.5 (1 - \text{ }^2) K\text{Ø} = K\text{ØB} / \text{ }^4 = \text{ØB} / \text{Ø}$

Note: SSID 9" and 24" not available.

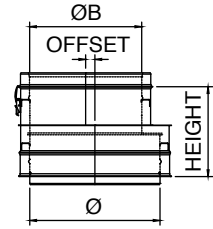

SSD Universal Muffler

Use to reduce the noise of an appliance. Install as a regular section in the evacuation line. No adapters required. Drain plug not included.

Ø	ØA	Effective Length	Product Code
6" to 14"	12" to 20"	37"	SSDØMUFFLERU

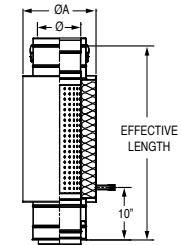

SSD & SSID Wall Thimble

Ø	Width	Product Code SSD	Product Code SSID
3" to 24"	9" to 17"	SSDØWT	SSIDØWT

Note: SSID 3", 9" and 24" not available.
Wall penetration opening dimensions available in the installation instructions manual.

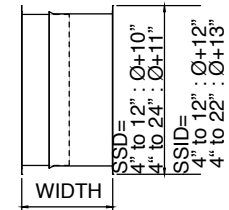
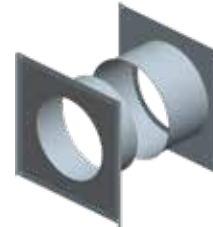

SSD & SSID Wall Thimble Insulated

Ø	Width	Product Code SSD	Product Code SSID
3" to 24"	9" to 17"	SSDØWTI	SSIDØWTI

Note: SSID 3", 9" and 24" not available.
Wall penetration opening dimensions available in the installation instructions manual.

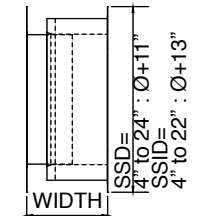
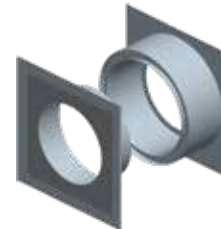

SSD & SSID Roof Thimble

Use when penetrating floor/roof levels.

Ø	Width	Product Code SSD	Product Code SSID
3" to 24"	10"	SSDØRTH	SSIDØRTH

Note: SSID 3", 9" and 24" not available.
Roof/floor penetration opening dimensions available in the installation instructions manual.

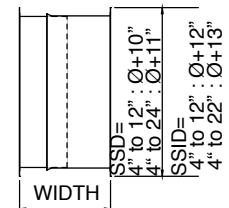

SSD & SSID Venting Accessories

SSD & SSID Roof Thimble Insulated

Ø	Width	Product Code SSD	Product Code SSID
3" to 24"	10"	SSDØRTI	SSIDØRTI

Note: SSID 3", 9" and 24" not available.
Roof penetration opening dimensions available in the installation instructions manual.

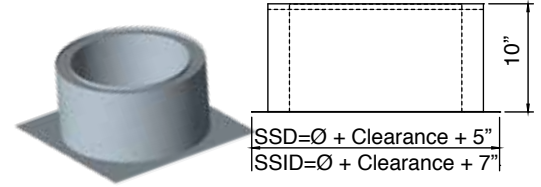

SSD & SSID Suspension Band

Ø	Product Code SSD	Product Code SSID
3" to 24"	SSDØSB	SSIDØSB

Note: SSID 3", 9" and 24" not available.



SSD & SSID Cradle Support

Ø	Product Code SSD	Product Code SSID
3" to 24"	SSDØCS	SSIDØCS

Note: SSID 3", 9" and 24" not available.

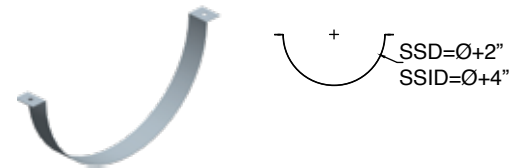

SSD & SSID Wall Support

Ø	A	Product Code SSD	Product Code SSID
3" to 24"	1" to 3"	SSDØWS	SSIDØWS

Note: SSID 3", 9" and 24" not available.

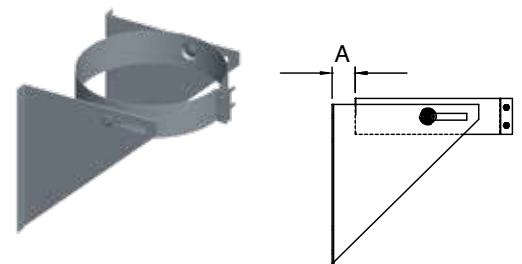

SSD Wall Support HD

Ø	A	B	C	Product Code SSD
3"	1-1/2" to 6-1/2"	8"	12"	SSD3WSHD
4"	1-1/2" to 6-1/2"	9"	12"	SSD4WSHD
5"	1-1/2" to 6-1/2"	10"	12"	SSD5WSHD
6"	1-1/2" to 6-1/2"	11"	12"	SSD6WSHD
7"	1-1/2" to 6-1/2"	12"	14"	SSD7WSHD
8"	1-1/2" to 6-1/2"	13"	14"	SSD8WSHD
9"	1-1/2" to 6-1/2"	14"	14"	SSD9WSHD
10"	1-1/2" to 6-1/2"	15"	16"	SSD10WSHD
12"	1-1/2" to 6-1/2"	17"	16"	SSD12WSHD
14"	1-1/2" to 6-1/2"	19"	22"	SSD14WSHD
16"	1-1/2" to 6-1/2"	21"	22"	SSD16WSHD
18"	1-1/2" to 6-1/2"	23"	26"	SSD18WSHD
20"	1-1/2" to 6-1/2"	25"	30"	SSD20WSHD
22"	1-1/2" to 6-1/2"	27"	30"	SSD22WSHD
24"	1-1/2" to 6-1/2"	29"	30"	SSD24WSHD

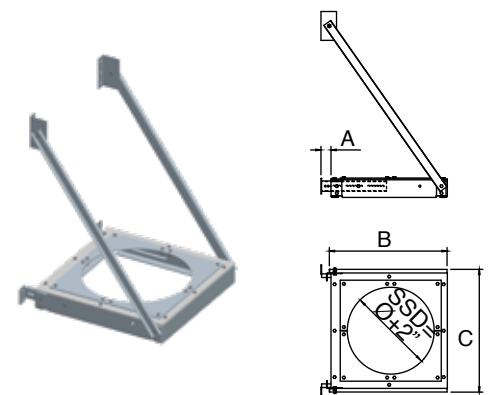

SSID Wall Support HD

SSD & SSID Venting Accessories

Ø	A	B	C	Product Code SSID
4"	1-1/2" to 6-1/2"	11"	12"	SSID4WSHD
5"	1-1/2" to 6-1/2"	12"	14"	SSID5WSHD
6"	1-1/2" to 6-1/2"	13"	14"	SSID6WSHD
7"	1-1/2" to 6-1/2"	14"	14"	SSID7WSHD
8"	1-1/2" to 6-1/2"	15"	16"	SSID8WSHD
10"	1-1/2" to 6-1/2"	17"	16"	SSID10WSHD
12"	1-1/2" to 6-1/2"	19"	22"	SSID12WSHD
14"	1-1/2" to 6-1/2"	21"	22"	SSID14WSHD
16"	1-1/2" to 6-1/2"	23"	26"	SSID16WSHD
18"	1-1/2" to 6-1/2"	25"	30"	SSID18WSHD
20"	1-1/2" to 6-1/2"	27"	30"	SSID20WSHD
22"	1-1/2" to 6-1/2"	29"	30"	SSID22WSHD

9" and 24" not available.

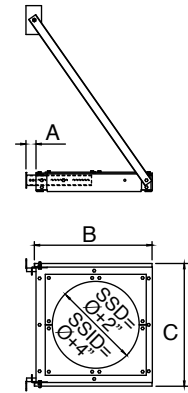

SSD & SSID Roof Support

Ø	A	B	Product Code SSD	Product Code SSID
3" to 24"	6-1/2"	7-5/8"	SSDØRS	SSIDØRS

Note: SSID 3", 9" and 24" not available.

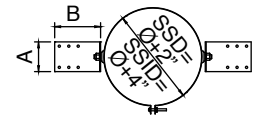

SSD & SSID Anchor Plate

Ø	A (SSD)	Product Code SSD	A (SSID)	Product Code SSID
3" to 24"	Ø+7"	SSDØAP	Ø+9"	SSIDØAP

Note: SSID 3", 9" and 24" not available.

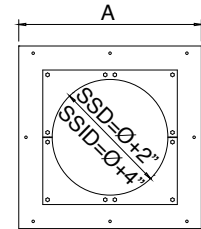
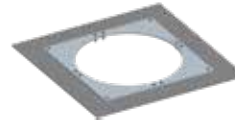

SSD & SSID Length Anchor Plate

Ø	A (SSD)	Product Code SSD	A (SSID)	Product Code SSID
3" to 24"	Ø+7"	SSDØAPL	Ø+9"	SSIDØAPL

Note: SSID 3", 9" and 24" not available.

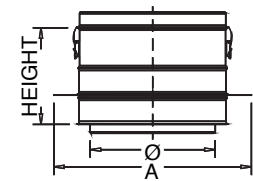
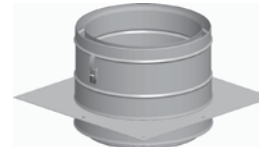

SSD & SSID Anchor Plate HD

Ø	A (SSD)	Product Code SSD	A (SSID)	Product Code SSID
3" to 24"	Ø+7"	SSDØAPHD	Ø+9"	SSIDØAPHD

Note: SSID 3", 9" and 24" not available.

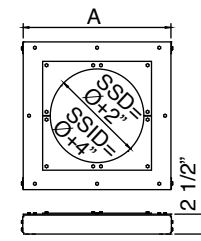
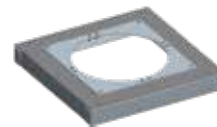

SSD & SSID Roof Brace

SSD & SSID Venting Accessories

Ø	Product Code SSD	Product Code SSID
3" to 24"	SSDØRB	SSIDØRB

Note: SSID 3", 9" and 24" not available.

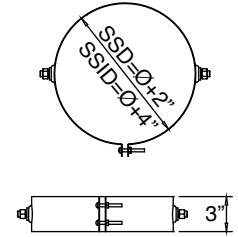

SSD & SSID Guy Wire Band

Ø	Product Code SSD	Product Code SSID
3" to 24"	SSDØGWB	SSIDØGWB

Note: SSID 3", 9" and 24" not available.

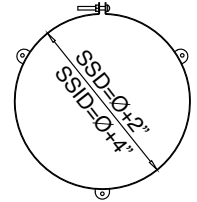

SSD & SSID Centering Band

Ø	Product Code SSD	Product Code SSID
3" to 24"	SSDØCB	SSIDØCB

Note: SSID 3", 9" and 24" not available.

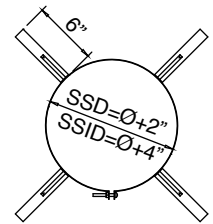

SSD & SSID Wall Guide

Ø	A	Product Code SSD	Product Code SSID
3" to 24"	1" to 4-1/2"	SSDØWG	SSIDØWG

Note: SSID 3", 9" and 24" not available.

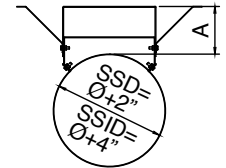

SSD & SSID Guy Support

Ø	Product Code SSD	Product Code SSID
3" to 24"	SSDØGS	SSIDØGS

Note: SSID 3", 9" and 24" not available.

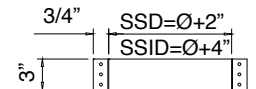

SSD & SSID Venting Accessories

SSD & SSID Double Male Adaptor

Ø	Effective Length	Product Code SSD	Product Code SSID
3" to 24"	7-1/8"	SSDØDMA	SSIDØDMA

Note: SSID 3", 9" and 24" not available.

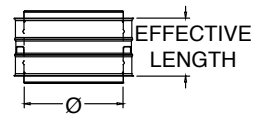

SSD & SSID Male Flange Adaptor

Ø	Effective Length	Product Code SSD	Product Code SSID
3" to 24"	5-1/2"	SSDØMFA	SSIDØMFA

Hardware not included.

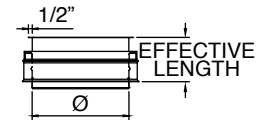

SSD & SSID Female Flange Adaptor

Ø	Effective Length	Product Code SSD	Product Code SSID
3" to 24"	6-7/8"	SSDØFFA	SSIDØFFA

Note: SSID 3", 9" and 24" not available.
Hardware not included.

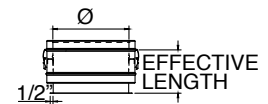

SSD & SSID to SS Adaptor

Ø	Effective Length	Product Code SSD	Product Code SSID
3" to 24"	7-7/8"	SSDØSSA	SSIDØSSA

Note: SSID 3", 9" and 24" not available.

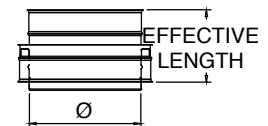

SSD to SSID Adaptor

Ø	Effective Length	Product Code SSD
3" to 24"	7-5/8"	SSDØSSIDA

Note: SSID 3", 9" and 24" not available.

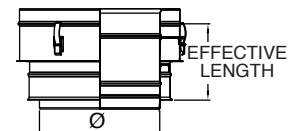

SSID to SSD Adaptor

Ø	Effective Length	Product Code SSD
3" to 24"	8-1/8"	SSIDØSSDA

Note: SSID 3", 9" and 24" not available.

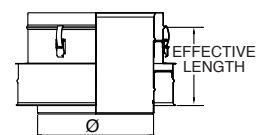

SSD & SSID Venting Accessories

SSD Flat Flashing

Use to create a weather tight penetration where the vent passes through the roof.

\emptyset	A	Product Code SSD
3"	14"	SSD3F
4"	16"	SSD4F
5"	18"	SSD5F
6"	26"	SSD6F
7"	26"	SSD7F
8"	28"	SSD8F
9"	30"	SSD9F
10"	30"	SSD10F
12"	31"	SSD12F
14"	34"	SSD14F
16"	36"	SSD16F
18"	38"	SSD18F
20"	40"	SSD20F
22"	42"	SSD22F
24"	44"	SSD24F

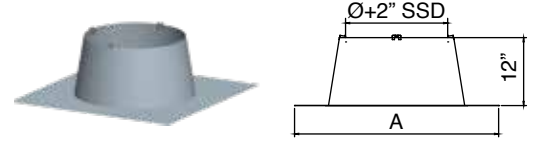

SSID Flat Flashing

Use to create a weather tight penetration where the vent passes through the roof.
9" and 24" not available.

\emptyset	A	Product Code SSID
4"	26"	SSID4F
5"	26"	SSID5F
6"	28"	SSID6F
7"	30"	SSID7F
8"	30"	SSID8F
10"	31"	SSID10F
12"	34"	SSID12F
14"	36"	SSID14F
16"	38"	SSID16F
18"	40"	SSID18F
20"	42"	SSID20F
22"	44"	SSID22F

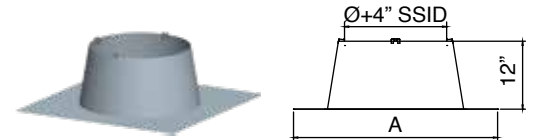

SSD & SSID Venting Accessories

SSD Adjustable Flashing

Ø	A	Height	Product Code SSD
3"	32"	12-1/2"	SSD3FA
4"	32"	12-1/2"	SSD4FA
5"	32"	12-1/2"	SSD5FA
6"	34"	12-1/2"	SSD6FA
7"	35-3/8"	12-1/2"	SSD7FA
8"	36-1/2"	12-1/2"	SSD8FA
9"	38"	12-1/2"	SSD9FA
10"	38-1/2"	12-1/2"	SSD10FA
12"	41"	12-1/2"	SSD12FA
14"	43"	12-1/2"	SSD14FA
16"	45"	12-1/2"	SSD16FA
18"	47-1/4"	12-1/2"	SSD18FA
20"	49-1/2"	12-1/2"	SSD20FA
22"	51-1/2"	12-1/2"	SSD22FA
24"	53-1/2"	12-1/2"	SSD24FA

Adjustable from 5° to 30°. Roof pitch 1/12" to 7/12".

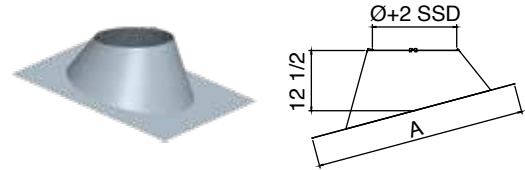

SSID Adjustable Flashing

Ø	A	Height	Product Code SSID
4"	34"	12-1/2"	SSID4FA
5"	35-3/8"	12-1/2"	SSID5FA
6"	36-1/2"	12-1/2"	SSID6FA
7"	38"	12-1/2"	SSID7FA
8"	38-1/2"	12-1/2"	SSID8FA
10"	41"	12-1/2"	SSID10FA
12"	43"	12-1/2"	SSID12FA
14"	45"	12-1/2"	SSID14FA
16"	47-1/4"	12-1/2"	SSID16FA
18"	49-1/2"	12-1/2"	SSID18FA
20"	51-1/2"	12-1/2"	SSID20FA
22"	53-1/2"	12-1/2"	SSID22FA

Adjustable from 5° to 30°. Roof pitch 1/12" to 7/12".
9" and 24" not available.

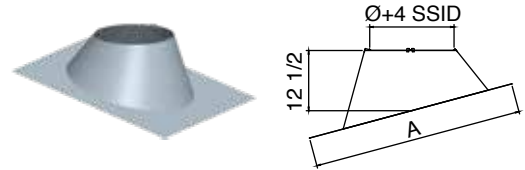

SSD & SSID Storm Collar

Use to create a weather tight seal between the pipe and flashing.

Ø	Product Code SSD	Product Code SSID
3" to 24"	SSDØSCH	SSIDØSC

Note: SSID 3", 9" and 24" not available.

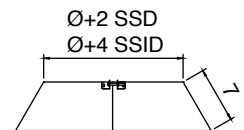

SSD & SSID Venting Terminations

SSD & SSID Rain Cap

Use to terminate above the roof line. Not recommended in cold climate as condensate can freeze on cap.

Ø	Product Code SSD	Product Code SSD w/ Bird Screen	K Factor	Product Code SSID	Product Code w/ SSID Bird Screen
3" to 24"	SSDØRC	SSDØRCB	.50	SSIDØRC	SSIDØRCB

Note: SSID 3", 9" and 24" not available.

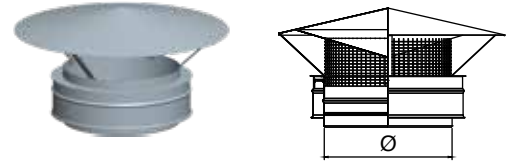

SSD & SSID Screened Termination

Use for horizontal through-the-wall terminations. Check installation instructions for restrictions on horizontal terminations, such as minimum distance from windows and doors.

Ø	Product Code SSD	Product Code SSID	K Factor
3" to 24"	SSDØST	SSIDØST	.14

Note: SSID 3", 9" and 24" not available.

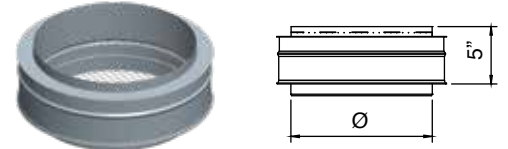

SSD & SSID 30° Screen Termination

Use for through-the-wall termination. Deters rain and other elements from entering the vent system. Check installation instructions for restrictions on horizontal terminations, such as minimum distance from windows and doors.

Ø	Product Code SSD	Product Code SSID	K Factor
3" to 24"	SSDØSTA	SSIDØSTA	.70

Note: SSID 3", 9" and 24" not available.

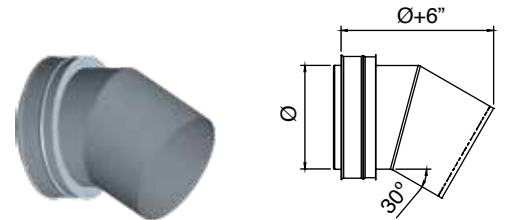

SSD 90° Screen Termination

Use for through-the-wall termination. Deters rain and other elements from entering the vent system. Check installation instructions for restrictions on horizontal terminations, such as minimum distance from windows and doors.

Ø	Product Code	K Factor
3" to 10"	SSDØST90A	.50

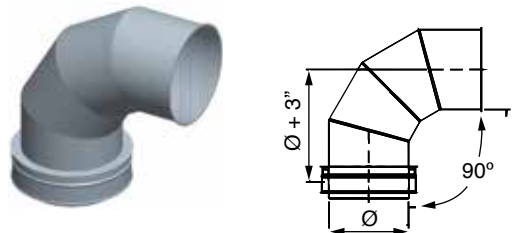

SSD & SSID Exit Cone

Use for vertical termination. Creates static back pressure to adjust harmonics. Venturi effect increases velocity of flue gases. Reduced opening provides for a smaller cross section to deter rain from entering the system.

Ø	Product Code SSD	Product Code SSID	K Factor
3" to 24"	SSDØEC	SSIDØEC	.60

Note: SSID 3", 9" and 24" not available.

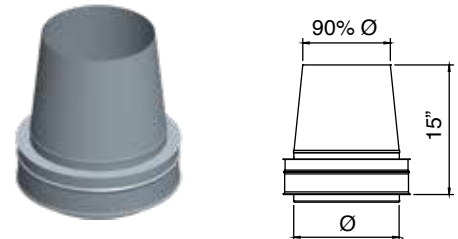

SSD & SSID Venting Terminations

SSD & SSID Termination Tee With Screen

Use for standard and high-wind through-the-wall terminations. Check installation instructions for restrictions on horizontal terminations, such as minimum distance from windows and doors.

Ø	Product Code SSD	Product Code SSID	K Factor
3" to 24"	SSDØTT	SSIDØTT	.35

Note: SSID 3", 9" and 24" not available.

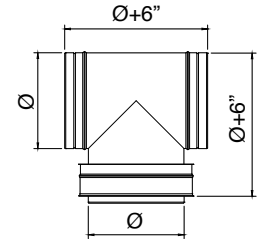

SSD & SSID Mitter Cut

Ø	Product Code SSD	Product Code SSID	K Factor
3" to 24"	SSDØMC	SSIDØMC	.14

Note: SSID 3", 9" and 24" not available.

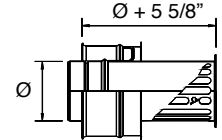

SSD & SSID Closer Termination

Ø	Product Code SSD	Product Code SSID	K Factor
3" to 24"	SSDØCT	SSIDØCT	0

Note: SSID 3", 9" and 24" not available.

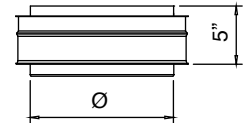

SSD & SSID OEM Termination

Ø	Product Code SSD	Product Code SSID	K Factor
3" to 24"	SSDØEMTA	SSIDØEMTA	0

Note: SSID 3", 9" and 24" not available.

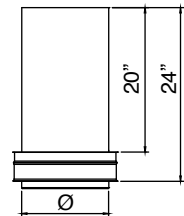

SS Venting Lengths

SS Lengths

Use to vent category II, III and IV appliances.

Ø	Effective Length	Product Code
3" to 24"	6-1/2"	SSØL9
3" to 24"	9-1/2"	SSØL12
3" to 24"	15-1/2"	SSØL18
3" to 24"	21-1/2"	SSØL24
3" to 24"	33-1/2"	SSØL36

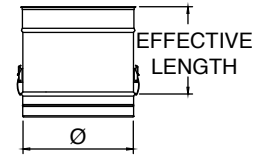

SS Adjustable Lengths

Use to add length to straight length of SS pipe. Adds 2"–14" of length. Requires at least 4" overlap for a secure connection.

Ø	Effective Length	Product Code
3" to 24"	4" to 5"	SSØAL9
3" to 24"	4" to 14"	SSØAL18

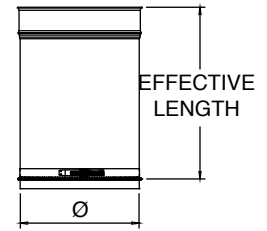

SS Test Port Lengths

Use to test for proper appliance operation without penetrating the vent wall. Easy access to perform flue gas analysis. Test port plug included.

Ø	Effective Length	Product Code
3" to 24"	6-1/2"	SSØTPL

Drain Ø4 – Ø24, 1/4 NPT, 1/2 O.D

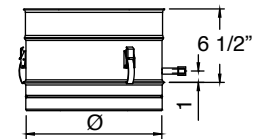

SS Drain Length

Use to properly manage corrosive condensates common with high efficiency gas appliances. For best results, install close to the appliance. Can be used horizontally, vertically, or any angle in between. Drain plug not included.

Ø	Effective Length	Product Code	K Factor
3" to 24"	6-1/2"	SSØDL	0.25

Drain Ø4 – Ø10, 1/4 NPT, 1/2 O.D
Drain Ø12 – Ø24, 1/2 NPT, 5/8 O.D



SS Damper Lengths

Ø	Effective Length	Product Code	K Factor
3" to 24"	21-3/16"	SSØDAMP	0.60 to 9999

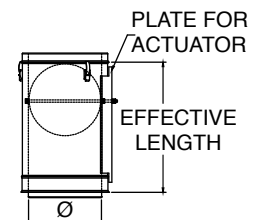

SS Venting Lengths

SS K&W Fixed Blade Damper Lengths

Ø	Effective Length	Product Code
6" to 18"	17-3/4"	SSØKWDAMP

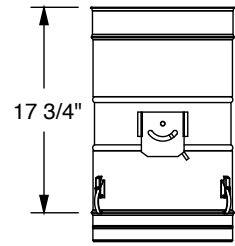

SS Motorized Damper Lengths

Ø	Effective Length	Product Code
3" to 18"	17-5/8"	SSØMOTDAMP

Note: SS 5", 7", 9", 11", 13", 15", and 17" not available.

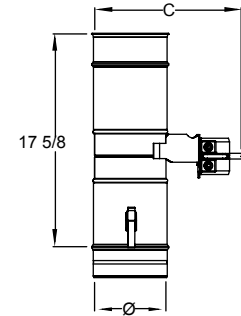

SS Telescopic Length

Telescopic lengths do not require cutting to fit dimension.

Ø	Effective Length	Product Code	
		32" Telescopic	20" Telescopic
3" to 24"	14" to 20"	SSØLAT32	SSØLAT20
3" to 24"	20" to 32"	SSØLAT32	SSØLAT20

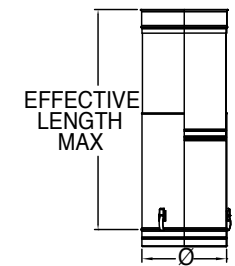

SS Damper Length Short

Ø	Effective Length	Product Code	K Factor
3" to 24"	6-3/16"	SSØDAMPS	0 to 9999

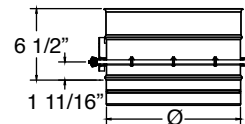

SS Vent Flow Regulator

Ø	Effective Length	Product Code	K Factor
3" to 24"	7-1/8"	SSØVFR	0 to 9999

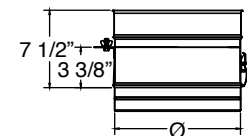

SS Venting Elbows

SS 2-Degree Elbow

Offsets obstructions as needed. Allows for better condensate management and less back pressure.

Ø	Offset	Rise	Product Code	K Factor
3" to 4"	1/8"	7-1/8"	SSØE2	0.04
5" to 8"	1/8"	7-1/4"	SSØE2	0.04
9" to 12"	1/8"	7-3/8"	SSØE2	0.04
14"	1/8"	7-1/2"	SS14E2	0.03
16" to 18"	1/8"	7-5/8"	SSØE2	0.03
20" to 22"	1/8"	7-3/4"	SSØE2	0.03
24"	1/8"	7-7/8"	SS24E2	0.03

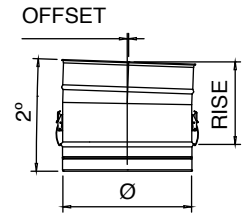

SS 15-Degree Elbow

Offsets obstructions as needed. Allows for better condensate management and less back pressure.

Ø	Offset	Rise	Product Code	K Factor
3"	1"	7-5/8"	SS3E15	0.32
4"	1"	7-7/8"	SS4E15	0.31
5"	1-1/8"	8-1/4"	SS5E15	0.30
6"	1-1/8"	8-1/2"	SS6E15	0.30
7"	1-1/8"	8-3/4"	SS7E15	0.29
8"	1-1/4"	9"	SS8E15	0.29
9"	1-1/4"	9-1/4"	SS9E15	0.28
10"	1-1/4"	9-1/2"	SS10E15	0.28
12"	1-3/8"	10"	SS12E15	0.27
14"	1-3/8"	10-1/2"	SS14E15	0.27
16"	1-1/2"	11"	SS16E15	0.26
18"	1-1/2"	11-1/2"	SS18E15	0.26
20"	1-5/8"	12-1/8"	SS20E15	0.26
22"	1-5/8"	12-5/8"	SS22E15	0.26
24"	1-3/4"	13-1/8"	SS24E15	0.26

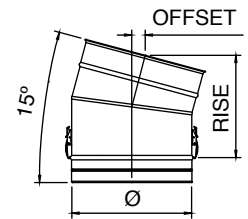

SS 30-Degree Elbow

Offsets obstructions as needed. Allows for better condensate management and less back pressure.

Ø	Offset	Rise	Product Code	K Factor
3"	2-1/8"	8"	SS3E30	0.62
4"	2-1/4"	8-1/2"	SS4E30	0.61
5"	2-3/8"	9"	SS5E30	0.60
6"	2-5/8"	9-1/2"	SS6E30	0.59
7"	2-3/4"	10"	SS7E30	0.58
8"	2-7/8"	10-1/2"	SS8E30	0.57
9"	3"	11"	SS9E30	0.56
10"	3-1/8"	11-1/2"	SS10E30	0.55
12"	3-3/8"	12-1/2"	SS12E30	0.54
14"	3-5/8"	13-1/2"	SS14E30	0.54
16"	3-7/8"	14-1/2"	SS16E30	0.53
18"	4-1/8"	15-1/2"	SS18E30	0.52
20"	4-1/2"	16-1/2"	SS20E30	0.52
22"	4-3/4"	17-1/2"	SS22E30	0.51
24"	5"	18-1/2"	SS24E30	0.51

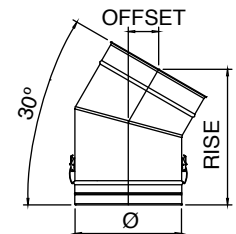

SS Venting Elbows

SS 45-Degree Elbow

Offsets obstructions as needed. Allows for better condensate management and less back pressure.

Ø	Offset	Rise	Product Code	K Factor
3"	3-3/8"	8-1/8"	SS3E45	0.30
4"	4-1/4"	10-1/4"	SS4E45	0.26
5"	4"	9-1/2"	SS5E45	0.22
6"	4-1/4"	10-1/2"	SS6E45	0.17
7"	4-1/2"	10-7/8"	SS7E45	0.16
8"	4-7/8"	11-5/8"	SS8E45	0.14
9"	5-1/8"	12-3/8"	SS9E45	0.13
10"	5-3/8"	13"	SS10E45	0.12
12"	6"	14-1/2"	SS12E45	0.11
14"	6-5/8"	15-7/8"	SS14E45	0.11
16"	7-1/8"	17-1/4"	SS16E45	0.10
18"	7-3/4"	18-3/4"	SS18E45	0.09
20"	8-3/8"	20-1/8"	SS20E45	0.08
22"	8-7/8"	21-1/2"	SS22E45	0.08
24"	9-1/2"	23"	SS24E45	0.08

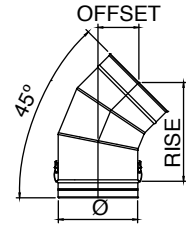

SS 88-Degree Elbow

Offsets obstructions as needed. Allows for better condensate management and less back pressure.

Ø	Offset	Rise	Product Code	K Factor
3"	6-3/8"	6-5/8"	SS3E88	0.60
4"	7-3/8"	7-5/8"	SS4E88	0.54
5"	8-3/8"	8-5/8"	SS5E88	0.48
6"	9-1/4"	9-5/8"	SS6E88	0.42
7"	10-1/4"	10-5/8"	SS7E88	0.39
8"	11-1/4"	11-5/8"	SS8E88	0.37
9"	12-1/4"	12-5/8"	SS9E88	0.34
10"	13-1/8"	13-5/8"	SS10E88	0.32
12"	15-1/8"	15-5/8"	SS12E88	0.29
14"	17"	17-5/8"	SS14E88	0.27
16"	19"	19-5/8"	SS16E88	0.25
18"	20-7/8"	21-5/8"	SS18E88	0.24
20"	22-7/8"	23-5/8"	SS20E88	0.23
22"	24-3/4"	25-5/8"	SS22E88	0.21
24"	26-5/8"	27-5/8"	SS24E88	0.20

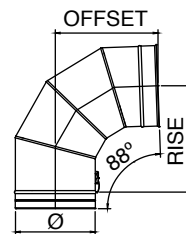

SS Venting Elbows

SS 90-Degree Elbow

Use to go from horizontal to vertical runs or vertical to horizontal runs. Use to turn vent 90°.

Ø	Offset	Rise	Product Code	K Factor
3"	6-1/2"	6-1/2"	SS3E90	0.60
4"	7-1/2"	7-1/2"	SS4E90	0.54
5"	8-1/2"	8-1/2"	SS5E90	0.48
6"	9-1/2"	9-1/2"	SS6E90	0.42
7"	10-1/2"	10-1/2"	SS7E90	0.39
8"	11-1/2"	11-1/2"	SS8E90	0.37
9"	12-1/2"	12-1/2"	SS9E90	0.34
10"	13-1/2"	13-1/2"	SS10E90	0.32
12"	15-1/2"	15-1/2"	SS12E90	0.29
14"	17-1/2"	17-1/2"	SS14E90	0.27
16"	19-1/2"	19-1/2"	SS16E90	0.25
18"	21-1/2"	21-1/2"	SS18E90	0.24
20"	23-1/2"	23-1/2"	SS20E90	0.23
22"	25-1/2"	25-1/2"	SS22E90	0.21
24"	27-1/2"	27-1/2"	SS24E90	0.20

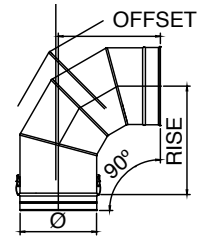

SS Venting Tees

SS 43-Degree Tee

Use in place of any tee for a 43° angle instead of 90°; can be used as a manifold connection to gang multiple boilers into a common vent.

Ø	Height	Offset	Rise	Product Code	K Factor
3"	13-1/4"	5-1/2"	10-3/8"	SS3T43	0.4
4"	14-1/4"	6-3/8"	11-1/8"	SS4T43	0.4
5"	15-1/4"	7-3/4"	12-7/8"	SS5T43	0.4
6"	17-1/4"	8-1/2"	13-3/4"	SS6T43	0.4
7"	18-1/4"	9-1/8"	14-3/4"	SS7T43	0.4
8"	20-1/4"	10-1/2"	16-3/8"	SS8T43	0.4
9"	21-1/4"	11-1/4"	17-1/4"	SS9T43	0.4
10"	22-1/4"	12-5/8"	19"	SS10T43	0.4
12"	25-1/4"	13-7/8"	20-3/4"	SS12T43	0.4
14"	29-1/4"	16"	23-3/8"	SS14T43	0.4
16"	32-1/4"	17-3/8"	25-1/4"	SS16T43	0.4
18"	35"	19-3/8"	27-7/8"	SS18T43	0.4
20"	38"	21-3/8"	30-3/8"	SS20T43	0.4
22"	41"	22-3/4"	32-1/4"	SS22T43	0.4
24"	44"	24-5/8"	34-5/8"	SS24T43	0.4

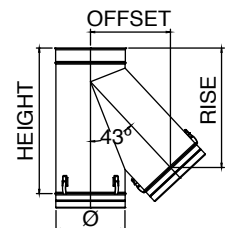

Available with smaller snout and custom height.

SS Venting Tees

SS 45-Degree Tee

Use in place of any tee for a 45° angle instead of 90°; can be used as a manifold connection to gang multiple boilers into a common vent.

Ø	Height	Offset	Rise	Product Code	K Factor
3"	13-1/4"	5-1/2"	10-3/8"	SS3T45	0.4
4"	14-1/4"	6-5/8"	11"	SS4T45	0.4
5"	15-1/4"	8-1/8"	12-5/8"	SS5T45	0.4
6"	17-1/4"	8-3/4"	13-1/2"	SS6T45	0.4
7"	18-1/4"	9-1/2"	14-3/8"	SS7T45	0.4
8"	20-1/4"	10-7/8"	16"	SS8T45	0.4
9"	21-1/4"	11-5/8"	17"	SS9T45	0.4
10"	22-1/4"	13"	17-5/8"	SS10T45	0.4
12"	25-1/4"	14-1/2"	20-3/8"	SS12T45	0.4
14"	29-1/4"	15-7/8"	22-1/4"	SS14T45	0.4
16"	32-1/4"	18-1/8"	24-7/8"	SS16T45	0.4
18"	35"	20-1/4"	27-1/2"	SS18T45	0.4
20"	38"	22-1/4"	29-7/8"	SS20T45	0.4
22"	41"	23-5/8"	31-5/8"	SS22T45	0.4
24"	44"	25-1/2"	34"	SS24T45	0.4

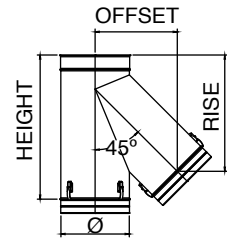

Available with smaller snout and custom height.

SS 88-Degree Tee

Use for a 88° offset, or to combine connections from two or more appliances into a common vent. Can also use as a condensate management point when used in conjunction with drain fitting. All Standard Tees are completely welded.

Ø	Height	Offset	Rise	Product Code	K Factor
3"	10-1/4"	5-3/8"	5-1/4"	SS3T88	1.21
4"	11-1/4"	6-3/8"	5-5/8"	SS4T88	1.21
5"	12-1/4"	7-3/8"	6-1/4"	SS5T88	1.21
6"	13-1/4"	7-3/8"	6-5/8"	SS6T88	1.21
7"	14-1/4"	8-3/8"	7-1/4"	SS7T88	1.21
8"	15-1/4"	8-3/8"	7-5/8"	SS8T88	1.21
9"	16-1/4"	9-3/8"	8-1/4"	SS9T88	1.21
10"	17-1/4"	9-3/8"	8-5/8"	SS10T88	1.21
12"	19-1/4"	10-3/8"	9-3/4"	SS12T88	1.21
14"	21-1/4"	11-3/8"	10-3/4"	SS14T88	1.21
16"	23-1/4"	12-3/8"	11-3/4"	SS16T88	1.21
18"	25-1/4"	13-3/8"	12-3/4"	SS18T88	1.21
20"	27-1/4"	14-3/8"	13-3/4"	SS20T88	1.21
22"	29-1/4"	15-3/8"	14-3/4"	SS22T88	1.21
24"	31-1/4"	16-3/8"	15-3/4"	SS24T88	1.21

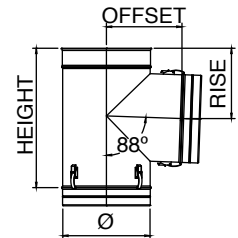

Available with smaller snout and custom height.

SS Venting Tees

SS 90-Degree Tee

Use for a 90° offset, or to combine connections from two or more appliances into a common vent. Can also use as a condensate management point when used in conjunction with drain fitting. All Standard Tees are completely welded.

Ø	Height	Offset	Rise	Product Code	K Factor
3"	10-1/4"	5-3/8"	5-1/4"	SS3T90	1.21
4"	11-1/4"	6-3/8"	5-1/2"	SS4T90	1.21
5"	12-1/4"	7-3/8"	6"	SS5T90	1.21
6"	13-1/4"	7-3/8"	6-1/2"	SS6T90	1.21
7"	14-1/4"	8-3/8"	7"	SS7T90	1.21
8"	15-1/4"	8-3/8"	7-1/2"	SS8T90	1.21
9"	16-1/4"	9-3/8"	8"	SS9T90	1.21
10"	17-1/4"	9-3/8"	8-1/2"	SS10T90	1.21
12"	19-1/4"	10-3/8"	9-1/2"	SS12T90	1.21
14"	21-1/4"	11-3/8"	10-1/2"	SS14T90	1.21
16"	23-1/4"	12-3/8"	11-1/2"	SS16T90	1.21
18"	25-1/4"	13-3/8"	12-1/2"	SS18T90	1.21
20"	27-1/4"	14-3/8"	13-1/2"	SS20T90	1.21
22"	29-1/4"	15-3/8"	14-1/2"	SS22T90	1.21
24"	31-1/4"	16-3/8"	15-1/2"	SS24T90	1.21

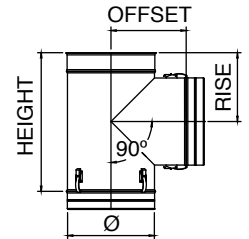

Available with smaller snout and custom height.
Available with removeable branch code: SSøT90BRU

SS 90-Degree Tee Y

Ø	Offset	Rise	Product Code	K Factor
3"	4-1/2"	8-1/2"	SS3TY90	0.6
4"	4-1/2"	8-1/2"	SS4TY90	0.6
5"	5-1/4"	10-1/8"	SS5TY90	0.6
6"	5-1/4"	10-1/8"	SS6TY90	0.6
7"	6"	10-7/8"	SS7TY90	0.6
8"	6"	10-7/8"	SS8TY90	0.6
9"	6-5/8"	12-5/8"	SS9TY90	0.6
10"	6-5/8"	12-5/8"	SS10TY90	0.6
12"	7-3/8"	13-1/4"	SS12TY90	0.6
14"	8-1/8"	15"	SS14TY90	0.6
16"	8-3/4"	16-3/4"	SS16TY90	0.6
18"	9-1/2"	17-3/8"	SS18TY90	0.6
20"	10-1/4"	18-1/8"	SS20TY90	0.6
22"	10-7/8"	18-7/8"	SS22TY90	0.6
24"	11-5/8"	20-1/2"	SS24TY90	0.6

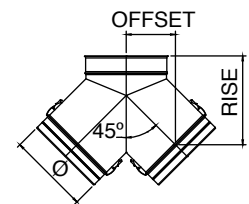

Available with smaller snout and custom height.

SS Venting Tees

SS Lateral Secure Tee

Use to transition from horizontal to vertical with improved flue gas flow.

Ø	Height	Offset	Rise	Product Code	K Factor
3"	9-1/8"	8-1/2"	7-3/4"	SS3BT	0.55
4"	10-1/8"	9-1/4"	8-7/8"	SS4BT	0.55
5"	12-1/8"	10-1/2"	10"	SS5BT	0.55
6"	13-1/8"	11-3/4"	11-1/8"	SS6BT	0.55
7"	15-1/8"	13"	12-1/4"	SS7BT	0.55
8"	16-1/8"	14-1/4"	13-3/8"	SS8BT	0.55
9"	18-1/8"	12-1/2"	12-1/2"	SS9BT	0.55
10"	19-1/8"	13-3/8"	13-3/8"	SS10BT	0.55
12"	22-1/8"	15-1/4"	15-1/4"	SS12BT	0.55
14"	25-1/8"	17"	17"	SS14BT	0.55
16"	28-1/8"	18-7/8"	18-7/8"	SS16BT	0.55
18"	30-7/8"	20-3/4"	20-1/2"	SS18BT	0.55
20"	33-7/8"	22-1/2"	22-1/2"	SS20BT	0.55
22"	36-7/8"	24-3/8"	24-3/8"	SS22BT	0.55
24"	39-7/8"	26-1/8"	26-1/4"	SS24BT	0.55

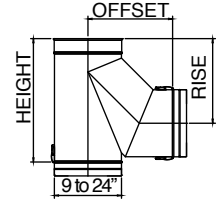
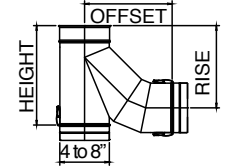

Available with smaller snout and custom height.

SS Lateral Secure Tee 88-Degree

Use to transition from horizontal to vertical with improved flue gas flow.

Ø	Height	Offset	Rise	Product Code	K Factor
3"	10-1/8"	8-1/2"	8-1/2"	SS3BT88	0.55
4"	11-1/8"	9-1/4"	9-1/4"	SS4BT88	0.55
5"	12-1/8"	10-1/2"	10-1/2"	SS5BT88	0.55
6"	14-1/8"	11-3/4"	11-3/4"	SS6BT88	0.55
7"	16-1/8"	13"	13"	SS7BT88	0.55
8"	17-1/8"	14-1/4"	14-1/8"	SS8BT88	0.55
9"	19-1/8"	12-5/8"	13-1/4"	SS9BT88	0.55
10"	20-1/8"	13-1/2"	14-1/4"	SS10BT88	0.55
12"	23-1/8"	15-3/8"	16-1/8"	SS12BT88	0.55
14"	26-1/8"	17-3/8"	18-1/8"	SS14BT88	0.55
16"	29-1/8"	19-1/8"	20-1/8"	SS16BT88	0.55
18"	31-7/8"	21"	22"	SS18BT88	0.55
20"	34-7/8"	22-7/8"	24"	SS20BT88	0.55
22"	37-7/8"	24-3/4"	26"	SS22BT88	0.55
24"	40-7/8"	26-5/8"	28"	SS24BT88	0.55

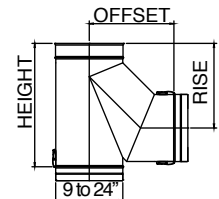
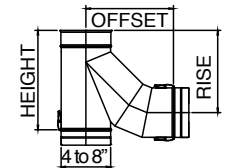

Available with smaller snout and custom height.

SS Venting Tees

SS Barometric Tee

Ø	Height	Offset	Rise	Product Code	K Factor
3"	10-1/4"	5"	5"	SS3BMT	0.2
4"	11-1/4"	5"	5-1/2"	SS4BMT	0.2
5"	12-1/4"	5"	6"	SS5BMT	0.2
6"	13-1/4"	6"	6-1/2"	SS6BMT	0.2
7"	14-1/4"	7"	7"	SS7BMT	0.2
8"	15-1/4"	8"	7-1/2"	SS8BMT	0.2
9"	16-1/4"	9"	8"	SS9BMT	0.2
10"	17-1/4"	10"	8-1/2"	SS10BMT	0.2
12"	19-1/4"	12"	9-1/2"	SS12BMT	0.2
14"	21-1/4"	14"	10-1/2"	SS14BMT	0.2
16"	23-1/4"	16"	11-1/2"	SS16BMT	0.2
18"	25-1/4"	18"	12-1/2"	SS18BMT	0.2
20"	27-1/4"	20"	13-1/2"	SS20BMT	0.2
22"	29-1/4"	22"	14-1/2"	SS22BMT	0.2
24"	31-1/4"	24"	15-1/2"	SS24BMT	0.2

Available with smaller snout and custom height.

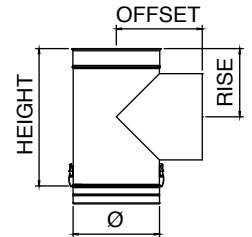

SS Tee Cap

Use to cap Standard Tee, Branch Tee or Boot Tee. Remove Tee Cap to inspect the system; clean out debris or collected condensate.

Ø	Height	Product Code
3" to 24"	3-1/2"	SSØTC

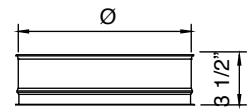

SS Drain Tee Cap

Use instead of Tee Cap to manage condensates at the bottom of a vertical run. Drain plug not included.

Ø	Height	Product Code
3" to 24"	3-1/2"	SSØDTC

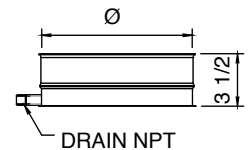

Drain Ø4 – Ø10, 1/4 NPT, 1/2 O.D.
Drain Ø12 – Ø24, 3/8 NPT, 5/8 O.D

SS Barometric Tee Cap

Ø	Height	Product Code
3" to 24"	3-1/2"	SSØBMTTC



SS Venting Tees

SS Tapered Inserter

Use to increase vent diameter. Creates a smooth transition for an undistruptive flow. Available in custom size combinations.

Ø	ØB Available	Height	Product Code	K Factor
3" to 9"	Ø+1"	11-7/8"	SSØTIN(ØB)	0.05
3" to 22"	Ø+2"	12-7/8"	SSØTIN(ØB)	0.10
3" to 9"	Ø+3"	13-7/8"	SSØTIN(ØB)	0.15
3" to 20"	Ø+4"	14-7/8"	SSØTIN(ØB)	0.20
3" to 7"	Ø+5"	15-7/8"	SSØTIN(ØB)	0.25
3" to 18"	Ø+6"	16-7/8"	SSØTIN(ØB)	0.30

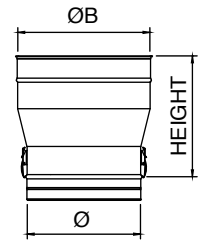

SS Step Inserter

Use to increase vent diameter when space constraints are an issue. Available in custom size combinations.

Ø	ØB Available	Height	Product Code	K Factor
3" to 22"	5" to 24"	10"	SSØSIN(ØB)	$KØ = (1-B)^2$ $KØB = KØ/B^4$

B= Ø/ØB

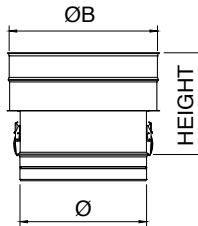

SS Eccentric Tapered Inserter

Use to transition to a larger diameter pipe. Prevents condensate puddling when used on horizontal runs. Aids in reducing formation of condensates. Available in custom size combinations.

Ø	ØB Available	Height	Offset	Product Code	K Factor
3" to 9"	Ø+1"	12-1/4"	1/2"	SSØETIN(ØB)	0.05
3" to 22"	Ø+2"	13-1/4"	1"	SSØETIN(ØB)	0.10
3" to 9"	Ø+3"	14-1/4"	1-1/2"	SSØETIN(ØB)	0.15
3" to 20"	Ø+4"	15-1/4"	2"	SSØETIN(ØB)	0.20
3" to 7"	Ø+5"	16-1/4"	2-1/2"	SSØETIN(ØB)	0.25
3" to 18"	Ø+6"	17-1/4"	3"	SSØETIN(ØB)	0.30

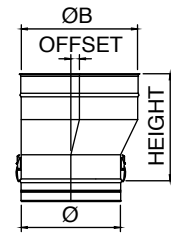

SS Eccentric Step Inserter

Ø	ØB Available	Height	Offset	Product Code	K Factor
3" to 22"	5" to 24"	10"	$(ØB-ØA)/2$ "	SSØESIN(ØB)	$KØ = (1-B)^2$ $KØB = KØ/B^4$

B= Ø/ØB

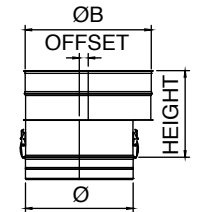

SS Venting Accessories

SS Tapered Reducer

Use to reduce vent diameter. Creates a smooth transition for an undistruptive flow. Available in custom size combinations.

Ø	ØB Available	Height	Product Code	K Factor
5" to 10"	Ø+1"	11-7/8"	SSØTRD(ØB)	0.07
6" to 24"	Ø+2"	12-7/8"	SSØTRD(ØB)	0.09
6" to 12"	Ø+3"	13-7/8"	SSØTRD(ØB)	0.11
8" to 24"	Ø+4"	14-7/8"	SSØTRD(ØB)	0.13
9" to 24"	Ø+5"	15-7/8"	SSØTRD(ØB)	0.15
10" to 24"	Ø+6"	16-7/8"	SSØTRD(ØB)	0.17

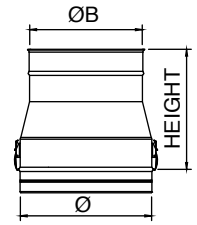

SS Step Reducer

Use to reduce vent diameter when space constraints are an issue. Available in custom size combinations.

Ø	ØB Available	Height	Product Code	K Factor
5" to 24"	4" to 22"	10"	SSØSRD(ØB)	$KØ = (1-B^2)^2$ $KØB = KØ/B^4$

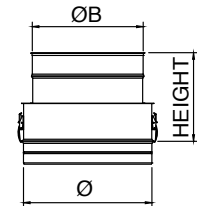

B= Ø/ØB

SS Eccentric Tapered Reducer

Ø	ØB Available	Height	Offset	Product Code	K Factor
5" to 10"	Ø+1"	12-1/4"	1/2"	SSØETRD(ØB)	0.07
6" to 24"	Ø+2"	13-1/4"	1"	SSØETRD(ØB)	0.09
6" to 12"	Ø+3"	14-1/4"	1-1/2"	SSØETRD(ØB)	0.11
8" to 24"	Ø+4"	15-1/4"	2"	SSØETRD(ØB)	0.13
9" to 24"	Ø+5"	16-1/4"	2-1/2"	SSØETRD(ØB)	0.15
10" to 24"	Ø+6"	17-1/4"	3"	SSØETRD(ØB)	0.17

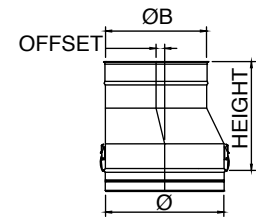

SS Eccentric Step Reducer

Ø	ØB Available	Height	Offset	Product Code	K Factor
5" to 10"	4" to 22"	10"	(ØA-ØB)/2"	SSØESRD(ØB)	$KØ = (1-B^2)^2$ $KØB = KØ/B^4$

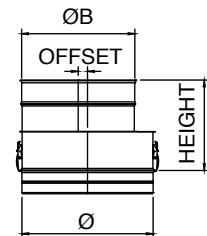

B= Ø/ØB

SS Wall Thimble

Use for through-the-wall installation. Fits between standard wall studs.

Ø	Height	Product Code
3" to 24"	9" to 17"	SSØWT

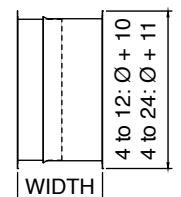
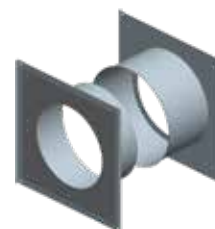

Wall penetration opening dimensions available in the installation instructions manual.

SS Venting Accessories

SS Wall Thimble Insulated

Ø	Height	Product Code
3" to 24"	9" to 17"	SSØWTI

Wall penetration opening dimensions available in the installation instructions manual.

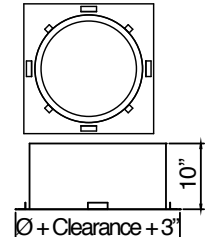
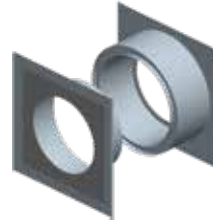

SS Roof Thimble

Ø	Height	Product Code
3" to 24"	10"	SSØRT

Roof/floor penetration opening dimensions available in the installation instructions manual.

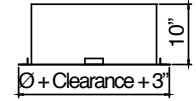

SS Roof Thimble Insulated

Ø	Height	Product Code
3" to 24"	10"	SSØRTI

Roof/floor penetration opening dimensions available in the installation instructions manual.

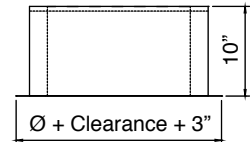
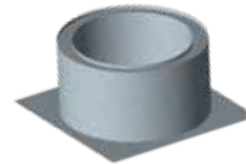

SS Suspension Band

Ø	Product Code
3" to 24"	SSØSB

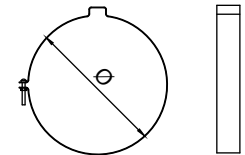

SS Cradle Support

Ø	Product Code
3" to 24"	SSØCS

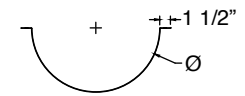

SS Wall Support

Use to support vent pipe or tee sections. Provides proper clearance to combustibles.

Ø	Height	Product Code
3" to 12"	2" to 5"	SSØWS
14" to 24"	4" to 7"	SSØWS

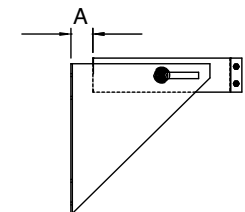
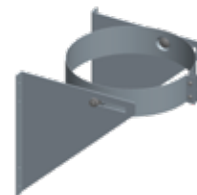

SS Venting Accessories

SS Wall Support HD

Ø	A	B	C	Product Code
3"	2" to 7"	7"	8"	SS3WSHD
4"	2" to 7"	7"	8"	SS4WSHD
5"	2" to 7"	9"	9"	SS5WSHD
6"	2" to 7"	12"	10"	SS6WSHD
7"	2" to 7"	12"	11"	SS7WSHD
8"	2" to 7"	12"	12"	SS8WSHD
9"	2" to 7"	14"	13"	SS9WSHD
10"	2" to 7"	14"	14"	SS10WSHD
12"	2" to 7"	16"	16"	SS12WSHD
14"	4" to 9"	22"	20"	SS14WSHD
16"	4" to 9"	22"	22"	SS16WSHD
18"	4" to 9"	26"	24"	SS18WSHD
20"	4" to 9"	26"	26"	SS20WSHD
22"	4" to 9"	30"	28"	SS22WSHD
24"	4" to 9"	30"	30"	SS24WSHD

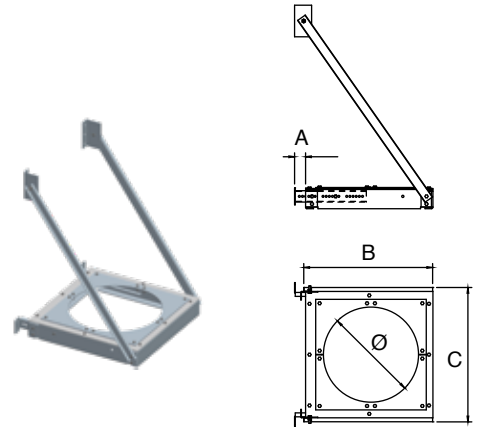

SS Roof Support

Ø	A	B	Product Code
3" to 12"	6-1/2"	7-5/8"	SSØRS
14" to 24"	22" to 32"		SSØRS

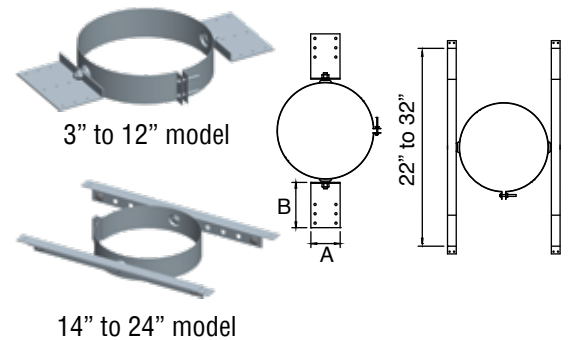

SS Anchor Plate

Use when penetrating floor levels.

Ø	A	Product Code
3" to 12"	Ø+7"	SSØAP
14" to 24"	Ø+11"	SSØAP

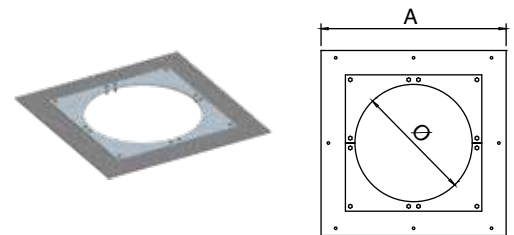

SS Length Anchor Plate

Ø	A	Product Code
3" to 12"	Ø+7"	SSØAPL
14" to 24"	Ø+11"	SSØAPL

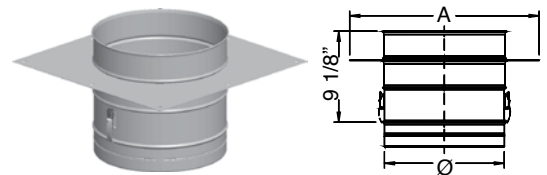

SS Venting Accessories

SS Anchor Plate HD

Use when penetrating floor levels.

\emptyset	A	Product Code
3" to 12"	$\emptyset+7"$	SS \emptyset APHD
14" to 24"	$\emptyset+11"$	SS \emptyset APHD

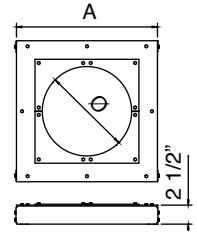
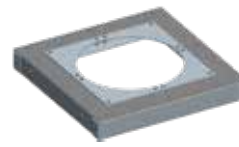

SS Roof Brace

\emptyset	Product Code
3" to 24"	SS \emptyset RB

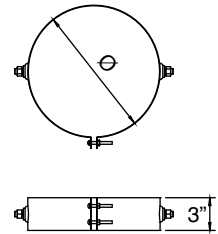

SS Guy Wire Band

\emptyset	Product Code
3" to 24"	SS \emptyset GWB

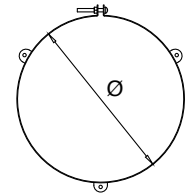

SS Centering Band

\emptyset	Product Code
3" to 24"	SS \emptyset CB

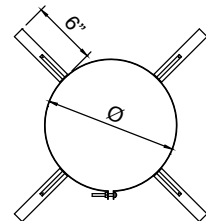

SS Wall Guide

\emptyset	A	Product Code
3" to 24"	2" to 5-1/2"	SS \emptyset WG
14" to 24"	4" to 7-1/2"	SS \emptyset WG

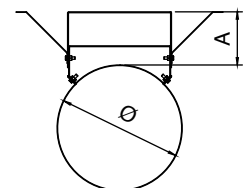

SS Venting Accessories

SS Guy Support

Ø	Product Code
3" to 24"	SSØGS

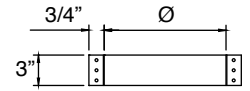

SS Double Male Adapter

Ø	Effective Length	Product Code
3" to 24"	3-7/8"	SSØDMA

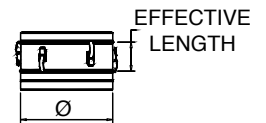

SS Male Flange Adapter

Ø	Effective Length	Product Code
3" to 24"	4-7/8"	SSØMFA

Hardware not included.

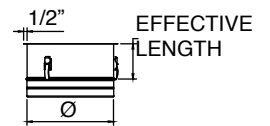

SS Female Flange Adapter

Ø	Effective Length	Product Code
3" to 24"	4-1/4"	SSØFFA

Hardware not included.

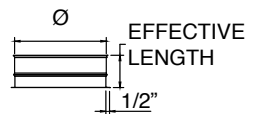

SS to SSD/SSID Adaptor

Ø	Effective Length	Product Code	Product Code
3" to 24"	7-7/8"	SSØSSDA	SSØSSIDA

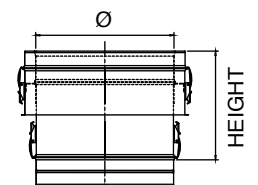

SS Venting Accessories

SS Flat Flashing

Ø	A	Product Code
3" to 6"	16"	SS_F
7"	18"	SS7F
8" to 9"	26"	SSØF
10"	28"	SS10F
12"	30"	SS12F
14"	31"	SS14F
16"	34"	SS16F
18"	36"	SS18F
20"	38"	SS20F
22"	40"	SS22F
24"	42"	SS24F

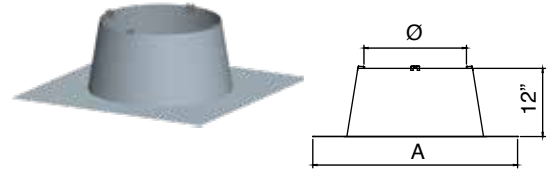

SS Adjustable Flashing

Ø	A	Height	Product Code
3" to 5"	30"	12-1/2"	SSØFA
6" to 7"	32"	12-1/2"	SS6FA
8"	34"	12-1/2"	SS8FA
9"	35-3/8"	12-1/2"	SS9FA
10"	36-1/2"	12-1/2"	SS10FA
12"	38-1/2"	12-1/2"	SS12FA
14"	41"	12-1/2"	SS14FA
16"	43"	12-1/2"	SS16FA
18"	45"	12-1/2"	SS18FA
20"	47-1/4"	12-1/2"	SS20FA
22"	49-1/2"	12-1/2"	SS22FA
24"	51-1/2"	12-1/2"	SS24FA



Adjustable from 5° to 30°.
Roof pitch 1/12" to 7/12".

SS Storm Collar

Ø	Effective Length	Product Code
3" to 24"	6-1/4"	SSØSC



SS Venting Accessoriess

SS Rain Cap

Use to terminate above the roof line. Not recommended in cold climate as condensate can freeze on cap.

Ø	Product Code	Product Code with Bird Screen	K Factor
3" to 24"	SSØRCU	SSØRCB	.50

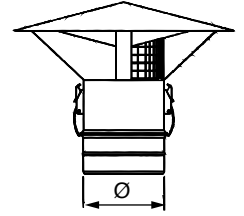

SS Screened Termination

Use for horizontal through-the-wall terminations. Check installation instructions for restrictions on horizontal terminations, such as minimum distance from windows and doors.

Ø	Product Code	K Factor
3" to 24"	SSØST	.14

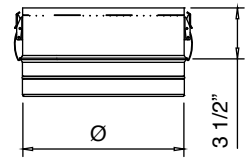

SS 30° Screen Termination

Use for through-the-wall termination. Deters rain and other elements from entering the vent system. Check installation instructions for restrictions on horizontal terminations, such as minimum distance from windows and doors.

Ø	Product Code	K Factor
3" to 24"	SSØSTA	.70

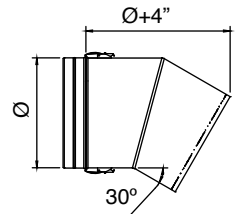

SS 90° Screen Termination

Use for through-the-wall termination. Deters rain and other elements from entering the vent system. Check installation instructions for restrictions on horizontal terminations, such as minimum distance from windows and doors.

Ø	Product Code	K Factor
3" to 10"	SSØST90A	.50

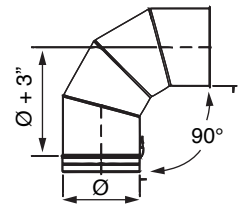

SS Exit Cone

Use for vertical termination. Creates static back pressure to adjust harmonics. Venturi effect increases velocity of flue gases. Reduced opening provides for a smaller cross section to deter rain from entering the system.

Ø	Product Code	K Factor
3" to 24"	SSØEC	.60

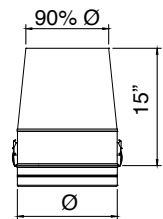

SS Venting Terminations

SS Termination Tee With Screen

Use for standard and high-wind through-the-wall terminations. Check installation instructions for restrictions on horizontal terminations, such as minimum distance from windows and doors.

Ø	Product Code	K Factor
3" to 24"	SSØTT	.35

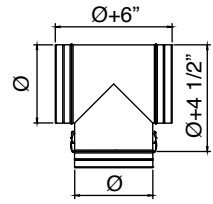

SS Mitter Cut

Ø	Product Code	K Factor
3" to 24"	SSØMC	.14

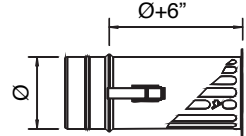

Secure Seal Flex

Secure Seal Flex

Use to vent Category II, III and IV gas burning appliances. Listed to UL 1738. Can only be used in vertical or near vertical runs.

Custom Flex Lengths 4"-9" diameter orders must be minimum 10' to maximum of 50' (increments of 10'). For 10"-12" diameters orders must be minimum 10' to maximum 25' (increments of 10').

Ø	Length	Product Code
3" to 8"	20'	SSØFLEX-20
3" to 8"	25'	SSØFLEX-25
3" to 8"	30'	SSØFLEX-30
3" to 8"	35'	SSØFLEX-35
3" to 8"	125'	SSØFLEX-125
3" to 12"	XX'	SSØFLEX-XX

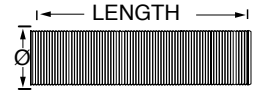

Adapter SS to Flex

Ø	Length	Product Code
3" to 12"	5 3/8'	SSØAMF

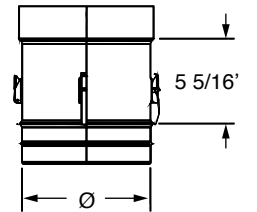

Adapter SS Flex to SS

Ø	Length	Product Code
3" to 12"	7 3/4'	SSØAFF

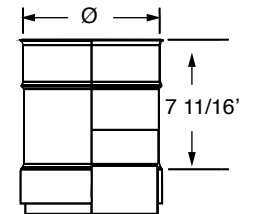

Adapter SS Flex to Flex

Ø	Length	Product Code
3" to 12"	5 3/4'	SSØAF

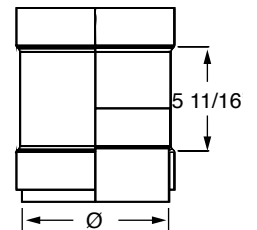

www.securitychimneys.com

Security Chimneys

2125 Monterey, Laval, Quebec
Canada, H7L 3T6

450-973-9999

800-361-4909 (US)

800-667-3387 (Canada)

450-973-2222 (Fax)

Need product information or technical support? Our customer service specialists are ready to answer your questions:

800-667-3387 or contact

infoeng@securitychimneys.com



www.securitychimneys.com 800-361-4909 (US) 800-667-3387 (Canada)

LS479_Catalog_Secure Seal_10-30-17_V3

Security Chimneys International © 2015 , 2017

Information published in all Security Chimneys literature is current at time of publication and is subject to change without notice.

ASS/SSD