

# Secure Pellet<sup>®</sup>

Venting for Biofuel Appliances



[www.securitychimneys.com](http://www.securitychimneys.com)  
800-361-4909 (US) 800-667-3387 (Canada)

# Secure Pellet®

## APPLICATIONS

The Security Chimneys model Secure Pellet vent is designed to offer unparalleled strength, resilience and installation ease. Available in 3- and 4-inch diameters with a 1-inch clearance to combustibles, the Secure Pellet is the ideal venting solution for: wood-, pellet- or multi-fuel burning stoves; low-temperature or liquid-fuel-burning appliances. The Secure Pellet venting system is listed with ITS (Intertek Testing Services) and the listing mark is Warnock Hersey. Tested in accordance with the following standards: UL-641, ULC-S609, ULC/ORD-C441 (standards for Safety Type L, low-temperature venting systems)

## A TRADITION OF EXCELLENCE

For over 50 years, Security Chimneys has been an innovator in the venting field and a market leader in North America. Instrumental in the company's growth has been an ongoing focus on product improvement and the introduction of new, innovative products. This drive for excellence has given rise to the Secure Pellet venting system, a line of high-quality products that deliver optimal performance.

## ENHANCED DURABILITY AND EASE OF INSTALLATION

As a reflection of our ongoing commitment to product quality, the Secure Pellet vent pipe, while reducing installation time and headaches, is engineered to be the most durable and easy-to-install product on the market today. Offered in 3- and 4-inch diameters, the Secure Pellet features a clearance to combustibles of only 1 inch, with improved air tightness at the connecting joint. Plus, with the small clearance to combustibles, the accessories feature a complementary design that makes installation simpler. A silicone gasket has been placed at each female joint to eliminate the need to caulk each joint. From a durability standpoint, Secure Pellet features enhanced materials that deliver unparalleled corrosion resistance. This includes a corrosion resistant stainless steel inner wall and a Galvalume outer casing. Both materials will help ensure product life and maintain a high level of dependable performance over a longer period of time.

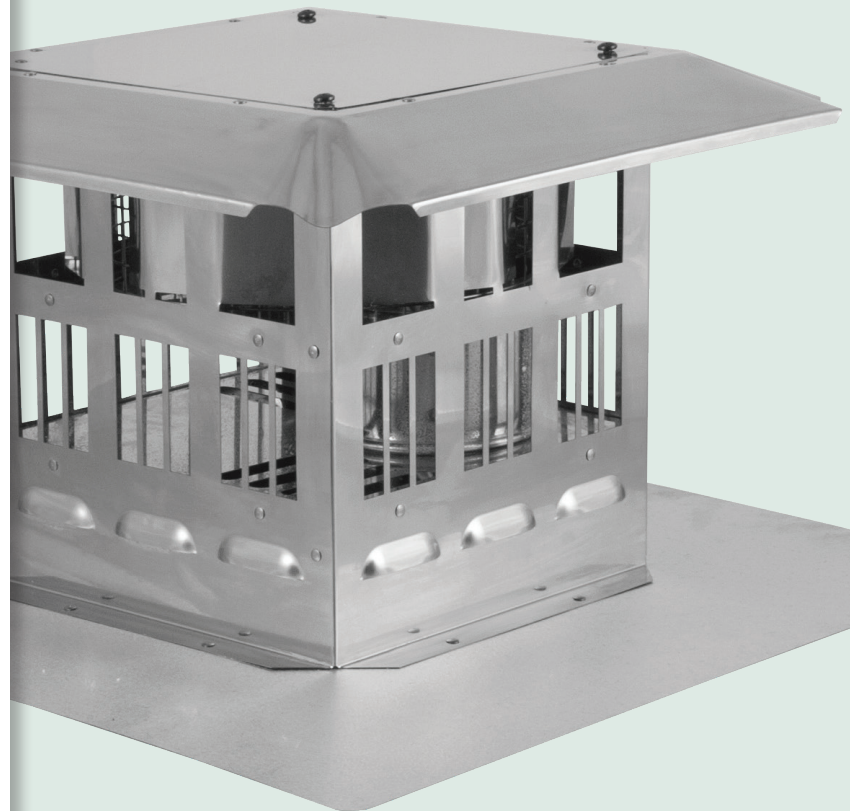



# SECURITY CHIMNEYS SECURE PELLET VENT SYSTEM FOR BIOFUELS



Features	Benefits
High-temperature-rated silicone gasket at each female joint	<ul style="list-style-type: none"> <li>• No need to caulk each joint</li> <li>• Makes installation fast and easy</li> </ul>
Corrosion resistant stainless steel	<ul style="list-style-type: none"> <li>• Applicable for corn-burning appliances</li> </ul>
Laser-welded	<ul style="list-style-type: none"> <li>• Creates a rounder pipe</li> <li>• Provides a better fit</li> <li>• Makes installation easier</li> </ul>
Galvalume outer casing	<ul style="list-style-type: none"> <li>• More corrosion resistance than galvanized steel</li> <li>• Enhances product life</li> <li>• Meets Canadian standard for vent outer casings</li> </ul>
Adjustable wall support	<ul style="list-style-type: none"> <li>• Multiple adjustments to the wall distance</li> <li>• Allows for easier installation</li> </ul>
Black pipe	<ul style="list-style-type: none"> <li>• Eliminates the need for painting on-site</li> <li>• Provides a better looking pipe inside the house</li> </ul>
Adjustable attic radiation shield	<ul style="list-style-type: none"> <li>• Allows for more types of installations</li> </ul>
Limited lifetime warranty	<ul style="list-style-type: none"> <li>• Allows for more types of installations</li> <li>• Assures a quality installation</li> </ul>

### INSTALLATION KEY

- 1 Vertical Cap
- 2 Storm Collar
- 3 Flashing
- 4 Cathedral Ceiling Support Box
- 5 Straight Length Pipe
- 6 45° Elbow
- 7 Appliance Adapter
- 8 Flex Length
- 9 90° Elbow
- 10 Horizontal Cap
- 11 Wall Thimble
- 12 Ceiling Support Firestop Spacer
- 13 Tee w/ Clean-Out Tee Cap
- 14 Wall Strap
- 15 Attic Insulation Shield
- 16 Prairie Termination Cap

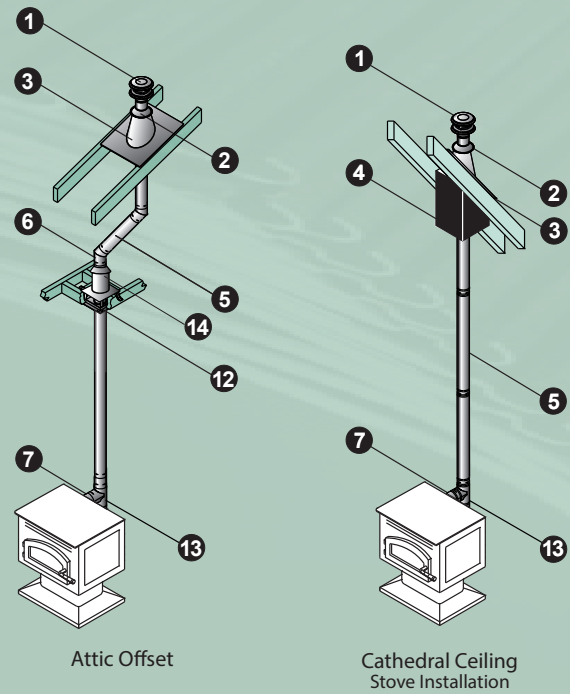

Refer to the Typical Secure Pellet Installations diagram, on the opposite page, to be familiar with some of the standard Secure Pellet installations and the required component parts.

For a horizontal termination, you will need a Wall Thimble and a Horizontal Cap. The cap must be installed with a 6" clearance to the outside wall (refer to appliance manufacturer's installation instructions for other clearances).

For a vertical termination, you will need a Cathedral Ceiling Support Box or Flat Ceiling Support, Attic Insulation Shield (if passing through an attic), Flashing, Storm Collar, and Vertical Cap.

Determine the length of Secure Pellet required. For a vertical termination, measure the pitch of the roof and select the proper flashing. The required minimum height above the roof is 12".

Pellet stove inserts in masonry fireplaces will require a flex pipe to snake the vent past the smoke shelf. For transition from Secure Pellet to an existing ASHT or S2100, a Chimney Adapter is available.

For vertical rise of Secure Pellet on the outside of the house, Wall Straps should be used at 4' intervals to provide proper support.

**Important!** Check to be sure that the appliance and the venting system are in compliance with all minimum clearance to combustible requirements.

### ELBOW OFFSET & RISE CHART

Elbow angle from vertical	Chimney length between elbows	0"	6"	12"	24"	36"	24" + 24"	60"	36" + 36"
		<b>45°</b>	03" Offset	3 3/4"	7"	11 1/4"	19 3/4"	28 1/2"	35 1/2"
	03" Rise	10 1/4"	13 1/2"	17 3/4"	26 1/4"	34 3/4"	42"	51 3/4"	59"
	04" Offset	4 1/4"	7 1/2"	11 3/4"	20 1/4"	28 3/4"	36"	45 3/4"	53"
	04" Rise	12 1/4"	15 1/2"	19 3/4"	28 1/4"	36 3/4"	44"	53 3/4"	61"
<b>90°</b>	03" Offset	8 1/4"	12 3/4"	18 3/4"	30 3/4"	42 3/4"	53 1/4"	66 3/4"	77 1/4"
	03" Rise	9 3/4"	9 3/4"	9 3/4"	9 3/4"	9 3/4"	9 3/4"	9 3/4"	9 3/4"
	04" Offset	10"	14 1/2"	20 1/2"	32 1/2"	44 1/2"	55"	68 1/2"	79"
	04" Rise	11 1/2"	11 1/2"	11 1/2"	11 1/2"	11 1/2"	11 1/2"	11 1/2"	11 1/2"

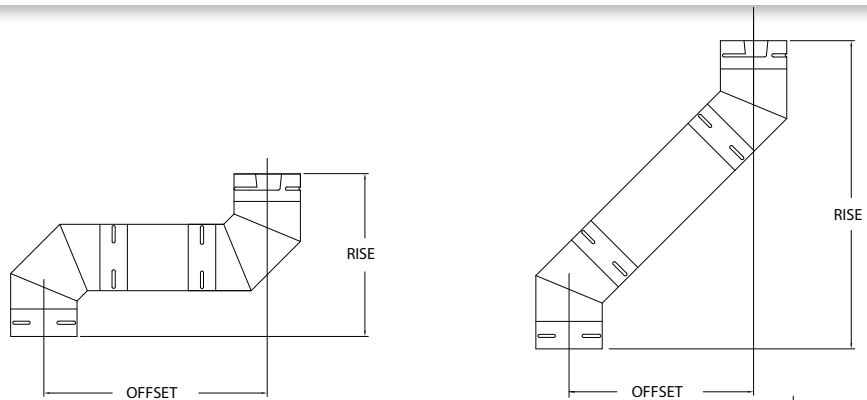

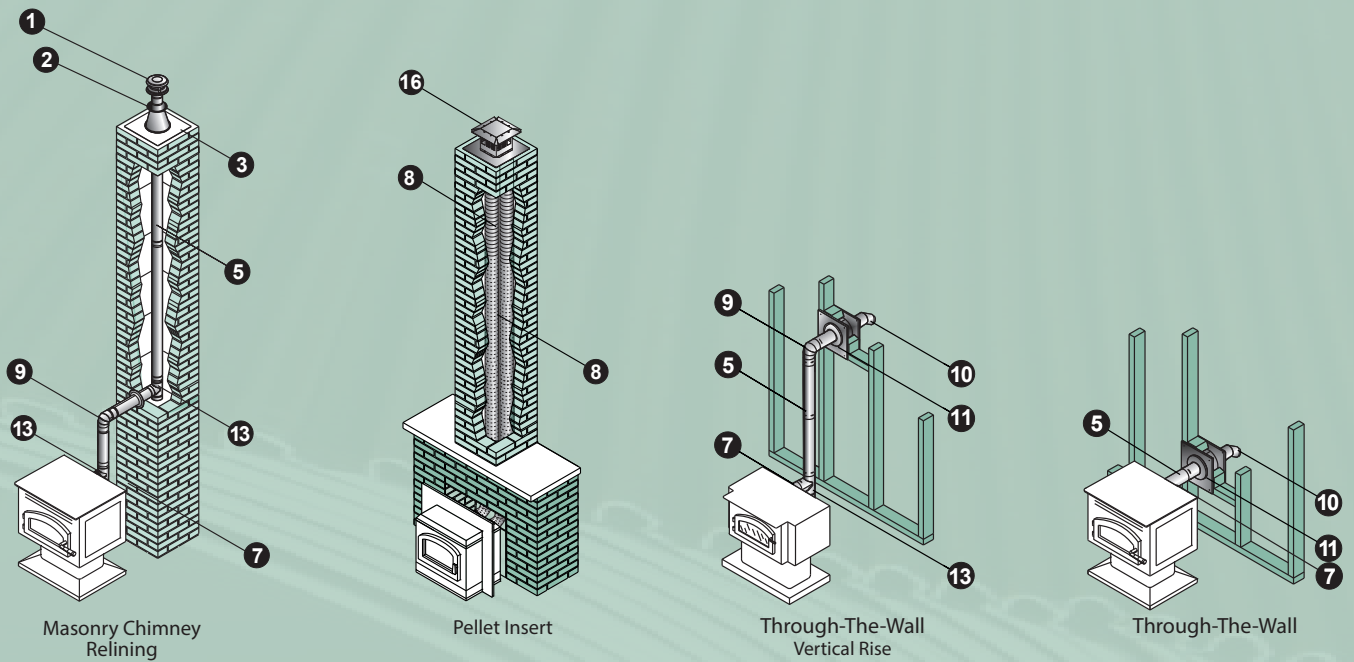

## Installation

The following recommendations are a general guideline to assist in the design and selection of venting components for your installation. Always follow Security Installation instructions before installing your chimney system (found with the cap or support box). Installation instructions can be viewed online at [www.securitychimneys.com](http://www.securitychimneys.com), under Residential Secure Pellet

- Size the vent to meet the appliance manufacturer's specifications.
- Avoid long runs and excessive use of elbows. Refer to the appliance manufacturer for minimum rise and maximum run configurations for the venting system.
- Use an Appliance Adapter to ensure a proper connection to appliance. Seal adapter to appliance with high temperature sealant.
- Use a Single Tee with Clean-Out Tee Cap to facilitate easy cleaning. It is recommended to use a tee off the back of an appliance.
- In the United States and Canada, maintain the minimum 1" clearance (air space) from vent pipe to combustibles. Use proper support and bracing. Follow local building codes and have your venting system inspected. Be fire safe!

1. Always follow the appliance manufacturer's instructions carefully.

- Choose an appliance that is listed by a recognized testing laboratory.
- Connect only one appliance per flue.
- Always maintain the appliance manufacturer's specified minimum clearances.
- Choose a location that minimizes offsets and degrees to allow the appliance to vent optimally.
- Do not install damaged parts.
- Refer to our Typical Venting Installation drawings to select the appropriate component parts for your installation.
- The inner pipe diameter should match the outlet size of the appliance. For installations that require 4" vent and the appliance has a 3" outlet, use an Increaser Adapter 3"-4".
- Check the appliance manufacturer's installation instructions to confirm which types of vent configurations are permitted (i.e. horizontal, vertical, chimney reline, etc.). Also, check for any venting restrictions such as maximum horizontal run, minimum and maximum vertical rise, maximum offset, etc.
- Be fire safe! Maintain the minimum clearances (air-space) between the vent pipe and nearby combustibles, as specified in the appliance manufacturer's installation instructions. Use proper support and bracing. Follow local building codes and have your venting system inspected.

2. The vent can be installed either vertically, horizontally or both, depending on your appliance location. Always use Security Chimneys firestop, support and accessories to ensure proper fitting of the installation.

3. The vent can be attached to an existing 6", 7" or 8" I.D. Type A pipe with our special adaptor. Secure Pellet can also be installed inside a masonry chimney.

# Kits

## Horizontal Kit

Kit includes: Round Horizontal Cap, Wall Thimble, and Appliance Adapter. Pipe lengths not included. 4" Kit includes a 3"-4" Appliance Adapter/Incraser, painted black.

Ø	Product Code	Product Code Black
3.00	3SPVHKIT	N/A
3.00	3SPVHKITC	N/A
4.00	4SPVHKIT	N/A



## Vertical Kit - Flat Ceiling

Kit includes: Vertical Cap, Storm Collar, Ceiling Support Firestop Spacer, Adjustable Flashing, and Appliance Adapter. Pipe lengths not included. 4" Kit includes a 3"-4" Appliance Adapter/Incraser, painted black. Support Clamp included.

Ø	Product Code	Product Code Black
3.00	3SPVVKIT	N/A
3.00	3SPVVKITC	N/A
4.00	4SPVVKIT	N/A



## Vertical Kit - Flat Ceiling

Kit includes: Vertical Cap, Storm Collar, Cathedral Ceiling Support Box with trim and clamp, Adjustable Flashing, and Appliance Adapter. Pipe lengths not included. 4" Kit includes a 3"-4" Appliance Adapter/Incraser, painted black.

Ø	Product Code	Product Code Black
3.00	3SPVCVKIT	N/A
4.00	4SPVCVKIT	N/A



## Fresh Air Intake Kit

Kit includes: faceplate with screen, moisture barrier, aluminum flex, and two clamps.

Allows fresh air into an existing pellet stove installation that had been using inside air. Allows an installer to decide the best possible location for the air intake vent, not the same location as the wall thimble. The 2" diameter, 18" length flex hose expands to approximately 60".

Ø	Product Code	Product Code Black
3.00	3SPVAIKIT	N/A



# Lengths

## Vent Lengths

Features fully unitized, twist-lock construction in 3" and 4" diameters. Listed at 1" clearance to combustibles in the USA and Canada. It can be used in both vertical and horizontal installations. Stainless steel laser welded inner wall, combined with a galvalume laser welded outer wall. Pipe OD is diameter plus 5/8". Galvalume or painted black outer finish. 12" length available with stainless steel outer (SS). To calculate installed length, subtract 1 1/2" from each length of pipe.

Ø	Length	Product Code	Product Code Black	Product Code SS
3.00	6.00"	3SPVL6	3SPVBL6	N/A
3.00	12.00"	3SPVL12	3SPVBL12	3SPVSSL12
3.00	24.00"	3SPVL24	3SPVBL24	N/A
3.00	36.00"	3SPVL36	3SPVBL36	N/A
3.00	60.00"	3SPVL60	3SPVBL60	N/A
4.00	6.00"	4SPVL6	4SPVBL6	N/A
4.00	12.00"	4SPVL12	4SPVBL12	N/A
4.00	24.00"	4SPVL24	4SPVBL24	N/A
4.00	36.00"	4SPVL36	4SPVBL36	N/A
4.00	60.00"	4SPVL60	4SPVBL60	N/A



## Adjustable Vent Lengths

Use to add length. 12" pipe adds 3"-10" of length, 18" pipe adds 3"-16" of length, when used with rigid sections of pipe. Galvalume or painted black outer finish.

Ø	A	Product Code	Product Code Black
3.00	3" - 10"	3SPVAL12	3SPVBAL12
3.00	3" - 16"	3SPVAL18	3SPVBAL18
3.00	4" - 46"	3SPVAL48	3SPVBAL48
4.00	3" - 10"	4SPVAL12	4SPVBAL12
4.00	3" - 16"	4SPVAL18	4SPVBAL18
4.00	4" - 46"	4SPVAL48	4SPVBAL48

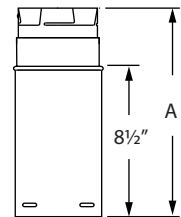



# Lengths

## Flexible Vent Lengths

Use for offsetting rigid pipe around smoke shelf in masonry chimney only. Allows for offsets with biofuel appliances. Female and male ends twist-lock. Female end swivels for easy alignment. 60" flex section. Not for use in attic or wall spaces.

Ø	Length	Product Code	Product Code Black
3.00	60.00"	3SPVFLEX	N/A
4.00	60.00"	4SPVFLEX	N/A



# Adapters

## Flex Trim Collar

Use to connect Secure Pellet rigid pipe to a masonry chimney with stainless steel flexible relining. Female end swivels to allow ease of connection.

Ø	A	B	Product Code	Product Code Black
3.00	3.375"	9"	N/A	3SPVFTC
4.00	4.625"	9"	N/A	4SPVFTC

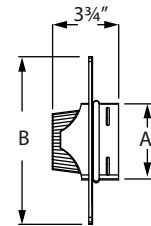

## Female Flex Adapter

Use to connect Secure Pellet to Secure Pellet Flex when relining a masonry chimney. Only approved for use with Secure Pellet Flex.

Ø	Product Code	Product Code Black
3.00	3SPVADFF	N/A
4.00	4SPVADFF	N/A

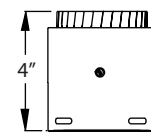

## Male Flex Adapter

Use to connect Secure Pellet Flex to Secure Pellet when relining a masonry chimney. Only approved for use with Secure Pellet Flex.

Ø	Product Code	Product Code Black
3.00	3SPVADFM	N/A
4.00	4SPVADFM	N/A

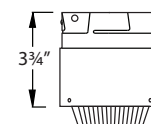



# Adapters

## Appliance Adapter

Use to attach to appliance outlet allowing for easy pipe connection. Seal adapter to appliance with high temperature sealant.

Ø	A	B	Product Code	Product Code Black
3.00	3.25"	3.75"	3SPVAD	3SPVBAD
4.00	3.125"	3.625"	4SPVAD	4SPVBAD

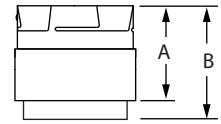

## Quick Release Adapter

Use to attach to appliance outlet allowing for easy pipe connection. Features an adjustable hose clamp and gasket to form a tight seal. The hose clamp can be loosened and tightened as needed to disconnect and connect the vent to the appliance.

Ø	Product Code	Product Code Black
3.00	3SPVADS	N/A
4.00	4SPVADS	N/A

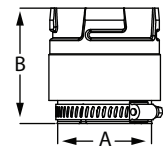

## Harman Adapter

Use to provide a secure, tight fit to the exhaust outlet on any Harman Pellet Stove. Seal with high temperature silicone sealant to insure a tight connection.

Ø	Product Code	Product Code Black
3.00	N/A	3SPVADHB



## Harman Adapter Increaser

Use to increase vent diameters. Specifically designed for Harman Pellet Stoves.

Ø	Product Code	Product Code Black
3.00	N/A	3SPVLBLW4HAB



# Adapters

## Appliance Adapter/Increaser

Use to attach to appliance outlet allowing for easy pipe connection. Allows connection of 4" vent to 3" appliance outlet. Seal adapter to appliance with high temperature sealant.

Ø	Product Code	Product Code Black
3.00	3SPVLW4AB	3SPVBLW4AB

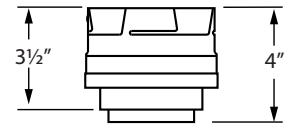

## Increaser

Use to transition from 3" pipe to a 4" pipe. Not a decrease or stove adapter.

Ø	Product Code	Product Code Black
3.00 - 4.00	3SPVLW4	N/A

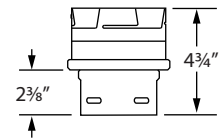

## Chimney Adapter

Use to transition between Secure Pellet to existing chimney such as Secure Temp ASHT+ or S2100+.

Ø	Product Code	Product Code Black
3.00	N/A	3SPVB6CA
3.00	N/A	3SPVB8CA
4.00	N/A	4SPVB6CA
4.00	N/A	4SPVB8CA

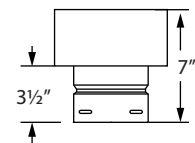

# Elbows

## 45° Elbow

Offsets obstructions as needed. Elbows swivel 360° at base. Angle not adjustable.

Ø	A	B	Product Code	Product Code Black
3.00	3.875"	4"	3SPVE45	3SPVBE45
4.00	3.875"	4"	4SPVE45	4SPVBE45

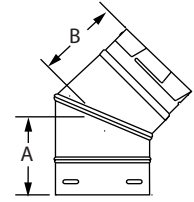

## 90° Elbow

Offsets obstructions as needed. Elbows swivel 360° at base. Angle not adjustable.

Ø	A	B	Product Code	Product Code Black
3.00	5.5"	5.5"	3SPVE90	3SPVBE90
4.00	5.5"	5.5"	4SPVE90	4SPVBE90

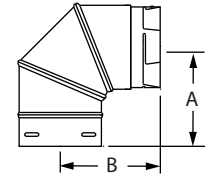

# Tees

## Regular Tees

Use for a 90° offset. Branch swivels for alignment. Removable twist-lock clean-out tee cap included.

Ø	A	B	C	Product Code	Product Code Black
3.00	8.5"	4.38"	4.25"	3SPVT1	3SPVBT1
4.00	9.69"	4.81"	4.75"	4SPVT1	4SPVBT1

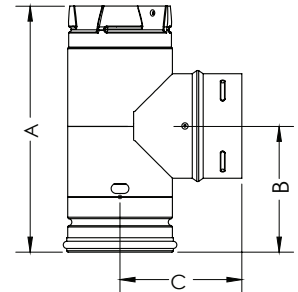

## Increaser Tee w/ Clean-Out Tee Cap

Attaches 3" pipe to branch and 4" pipe to body. Use for a 90° offset. Branch swivels for alignment. Removable twist-lock clean-out tee cap included.

Ø	A	B	C	Product Code	Product Code Black
4.00	9"	4.25"	5.06"	4SPVTW41	4SPVBTW41

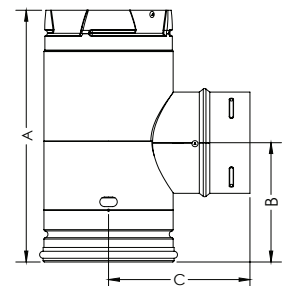

# Tees

## Adapter Tee w/ Clean-Out Tee Cap

Use for a 90° offset. Attaches directly to appliance as an adapter. Removable twist-lock Clean-Out Tee Cap.

A	B	C	D	E	Product Code	Product Code Black
3"	3.63"	8.5"	4.38"	5.75"	3SPVTAB1	3SPVBTAB1
4"	4.63"	9.69"	4.81"	6.44"	4SPVTAB1	4SPVBTAB1

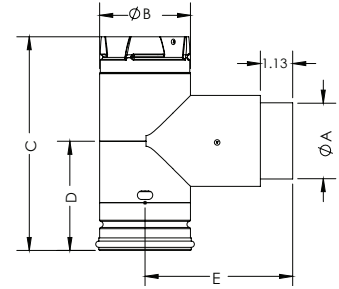

## Increaser Adapter Tee w/ Clean-Out Tee Cap

Use for a 90° offset. Attaches directly to appliance as an adapter. Converts a 3" appliance to a 4" Secure Pellet system. Removable twist-lock Clean-Out Tee Cap.

Ø	Product Code	Product Code Black
3.00	3SPVTABW41	3SPVBTABW41

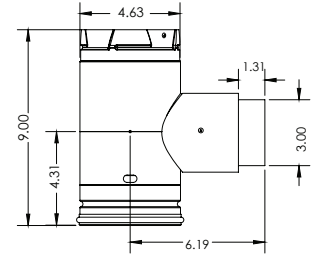

## Double Tee w/ Clean-Out Tee Cap

Allows clean-out access for horizontal and vertical installations. Use for a 90° offset. Branch swivels for alignment. Removable twist-lock Clean-Out Tee Cap.

A	B	C	D	E	Product Code	Product Code Black
3.63"	4.25"	5.75"	8.5"	4.38"	3SPVTX1	3SPVBTX1
4.63"	5"	6.39"	9.69"	4.81"	4SPVTX1	4SPVBTX1

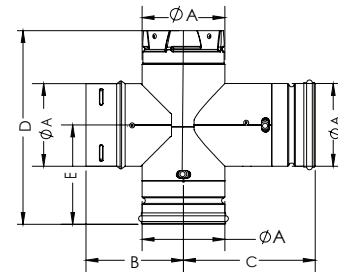

## Clean-Out Tee Cap

Use as a replacement Clean-Out Tee Cap. The new PelletVent Pro Tee Cap is a tight fit by design. We recommend using rubber gloves or a strap wrench to easily remove.

Ø	Product Code	Product Code Black
3"	3SPVC01	3SPVC0B1
4"	4SPVC01	4SPVC0B1

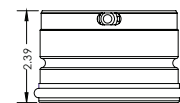

## Replacement Gaskets

Use as a replacement gasket for Pellet Vent Clean-out Tee Caps. Available in packs of 12 for 3" and 4" sizes.

Ø	Product Code	Product Code Black
3"	3SPVC01	3SPVC0B1
4"	4SPVC01	4SPVC0B1





# Supports

## Wall Thimble

Use for through-the-wall installations. Fits between standard wall studs. Comes with an insulation ring to reduce air infiltration where the pipe slips through the thimble.

A	Product Code	Product Code Black
3.75"	3SPVWT	N/A
4.75"	4SPVWT	N/A

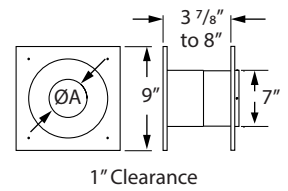

## Wall Thimble Air Intake Kit

Allows outside fresh air for combustion through the wall thimble without having to cut a second hole into the wall. Comes with an insulation ring to reduce air infiltration where the pipe slips through the thimble. The 2" diameter, 18" length flex hose expands to 5". Clamps included. Can be used in US and Canada. Patented.

Ø	Product Code	Product Code Black
3.00	3SPVWTI	N/A
4.00	4SPVWTI	N/A
4.00	4SPVWTI3	N/A

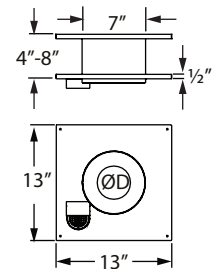

## Ceiling Support Firestop Spacer

Required where vent passes through ceiling. Centers pipe to provide proper 1" clearance. Support Clamp included. Painted black.

A	Product Code	Product Code Black
3.75"	N/A	3SPVSBF
4.75"	N/A	4SPVSBF

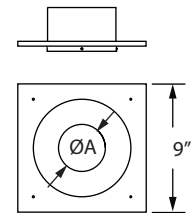
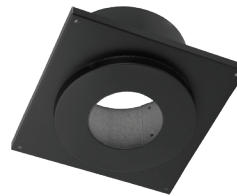

## Ceiling Support Firestop Spacer - 3" Clearance

Required where vent passes through ceiling. Centers pipe to provide 3" clearance. Support Clamp included. Painted black.

A	Product Code	Product Code Black
3.75"	N/A	3SPVBF3
4.75"	N/A	4SPVBF3

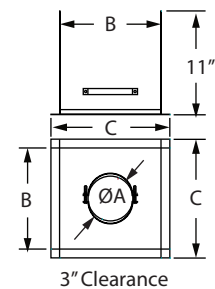
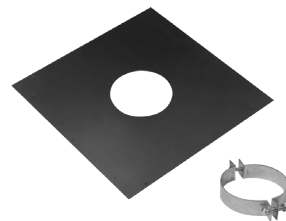

# Supports

## Wall Strap

Use to support vent pipe or tee sections. Provides 1" clearance.

A	Product Code	Product Code Black
3.625"	3SPVWS	N/A
4.625"	4SPVWS	N/A

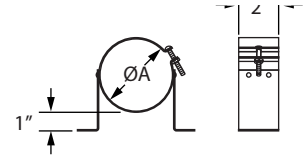

## Adjustable Wall Strap

Use to support vent pipe or tee sections. Adjusts to provide 1" - 3" clearance.

A	Product Code	Product Code Black
3.625"	3SPWWSA	N/A
4.625"	4SPWWSA	N/A

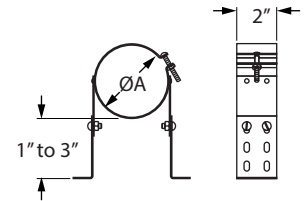

## Wall Strap Extension

Use with Adjustable Wall Strap to increase extension from wall. Fits both 3" and 4" Adjustable Wall Strap.

Ø	Product Code	Product Code Black
3.00 - 4.00	3SPVWSAEXT	N/A

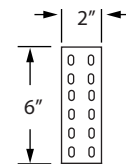

## Cathedral Ceiling Support Box

Use to support pipe. May be used on flat ceilings. Painted black. Trim and clamp included.

A	Product Code	Product Code Black
3.75"	N/A	3SPVCS
4.75"	N/A	4SPVCS

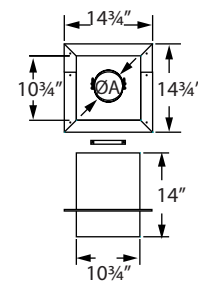

# Supports

## Ceiling Support/Wall Thimble Cover

Decorative cover for ceiling support boxes and wall thimbles. Painted black. Use with reduction collar.

Ø	Product Code	Product Code Black
3.00 - 4.00	3SPVWTC	N/A

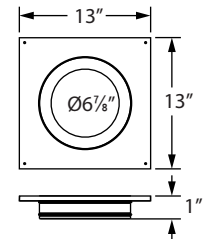

## Reduction Collar

Reduces the center hole diameter in the Ceiling Support /Wall Thimble Cover to fit 3" or 4" pipe. Can be used as trim collar when penetrating a masonry chimney with Secure Pellet. Painted black.

Ø	Product Code	Product Code Black
3.00	3SPVRC	N/A
4.00	4SPVRC	N/A

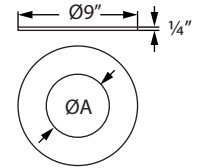

## House Shield

Use to protect exterior of structure from blower discharge in horizontal venting applications.

A	Product Code	Product Code Black
3.75"	3SPVHS	N/A
4.75"	4SPVHS	N/A

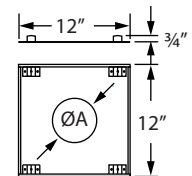

## Attic Insulation Shield

Required for installations that pass through an attic to prevent insulation and debris from accumulating near the vent. Provides 1" clearance to combustibles.

A	Product Code	Product Code Black
3.75"	3SPVRSA	N/A
4.75"	4SPVRSA	N/A



# Flashings

## Adjustable Roof Flashing

Use to weather proof the penetration of vent pipe through the roof. Storm Collar required. Select roof flashing based on pitch of roof. For pitches of 0/12 - 6/12.

A	Product Code	Product Code Black
3.75"	3SPVFA	N/A
4.75"	4SPVFA	N/A

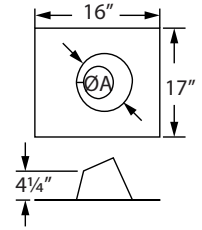
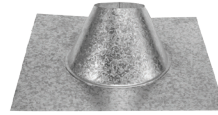

## Tall Cone Roof Flashing

Use to weather proof the penetration of vent pipe through the roof. Storm Collar required. Select roof flashing based on pitch of roof. Use on flat roofs, chase enclosures, or masonry chimney. Made of galvalume.

A	Product Code	Product Code Black
3.75"	3SPVF	N/A
4.75"	4SPVF	N/A

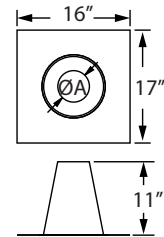
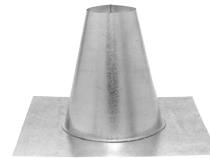

## DSA Roof Flashings

Use with metal or tile roofs. Available in sizes 3" and 4", in 0/12-6/12 (shown) and 7/12-12/12 styles. Made of dead soft aluminum.

A	B	C	Product Code	Product Code Black
3.75"	19.375"	23"	3SPVFAA	N/A
3.75"	19.375"	23"	3SPVFBA	N/A
4.75"	19.375"	23"	4SPVFAA	N/A
4.75"	19.375"	23"	4SPVFBA	N/A

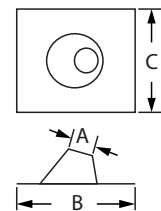
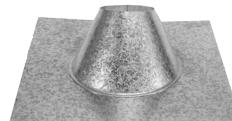

## Storm Collar

Use to maintain a weather tight resistant seal between the pipe and the flashing.

$\varnothing$	Product Code	Product Code Black
3.00	3SPVFC	N/A
4.00	4SPVFC	N/A





# Caps

## Vertical Cap

Use for vertical installations only. Required where pipe terminates above the roof line.

Ø	Product Code	Product Code Black
3.00	3SPVVC	N/A
4.00	4SPVVC	N/A

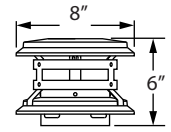

## Horizontal Cap

Use for horizontal terminations only. The Horizontal Cap can be turned at the gore to direct exhaust output. Designed to create a venturi effect to force exhaust out. Made of a laser-welded, super-ferritic stainless steel inner wall that is scientifically proven to resist corrosion from corn and other biofuels. Outer wall made of laser-welded stainless steel.

Ø	Product Code	Product Code Black
3.00	3SPVHC	N/A
4.00	4SPVHC	N/A

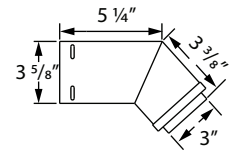

## Square Horizontal Cap

Use for horizontal terminations only. Cap features swivel collar to adjust exhaust direction. Cap features an optional swivel base.

Ø	Product Code	Product Code Black
3.00	3SPVHSC	N/A
4.00	4SPVHSC	N/A

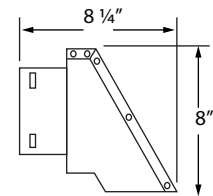

# Pellet Relining

## Secure Pellet Flex

Use when relining masonry chimney for use with pellet appliances. Made of super-ferritic stainless steel. Must be used with Secure Pellet Male and Female Flex Adapters. Rigid pipe must be used when terminating system.

Length	Product Code Ø3	Product Code Ø4
15' Flex	3SPVFLEX15	4SPVFLEX15
20' Flex	3SPVFLEX20	4SPVFLEX20
25' Flex	3SPVFLEX25	4SPVFLEX25
30' Flex	3SPVFLEX30	4SPVFLEX30
35' Flex	3SPVFLEX35	4SPVFLEX35
100' Flex	3SPVFLEX100	4SPVFLEX100



## Prairie Termination Cap

Use when installing a pellet insert into a multi-fuel pellet stove. This termination cap supplies both fresh air and vents exhaust. Lid pivots open for cleaning with three Removable screws and one rivet. Flex sold separately.

304SS and 316SS flex can be used when burning most fuels. If burning corn, super-ferritic stainless steel Secure Pellet Flex must be used as the exhaust vent. For fresh air, aluminum flex can be used. Stainless steel flex is not required for the fresh air supply unless specified by the appliance manufacturer.

Ø	Product Code	Product Code Black
3.00	4SPVCT34	3SPVBTCT33
4.00	4SPVBTCT34	3SPVBTCT33

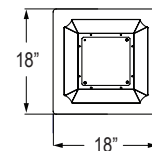
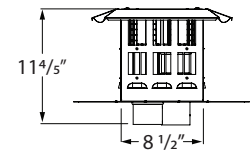
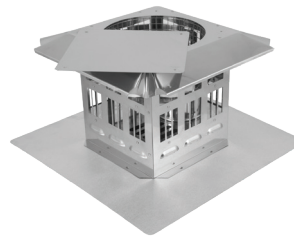

## Fresh Air Inlet Increaser

Use to increase an insert's 2" air inlet to connect to 3" aluminum flex.

Ø	Product Code	Product Code Black
3.00	3SPVINC	N/A

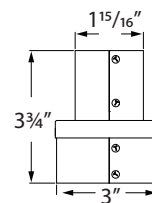

# Limited Lifetime Warranty

This Security Chimneys International, Ltd. (SCIL) Limited Lifetime Warranty warrants your residential vent and/or chimney system to be free from defects in material and workmanship at the time of manufacture. This Limited Lifetime Warranty includes all components and fittings, except termination caps and Secure Black SW single wall black stove pipe. After installation, if covered components manufactured by SCIL are found to be defective in materials or workmanship during the Limited Lifetime Warranty period and while the Product remains at the site of the original installation, SCIL will, at its option, replace the covered components. SCIL reserves the right to replace covered components with an equivalent product and the replacement must be carried out in accordance with SCIL's recommendations. If replacement is not commercially practical, SCIL will, at its option, refund the purchase price or wholesale price of the SCIL product, whichever is applicable. THERE ARE EXCLUSIONS AND LIMITATIONS to this Limited Lifetime Warranty as described herein.

## COVERAGE COMMENCEMENT DATE

Warranty coverage begins on the date of installation. In the case of new home construction, warranty coverage begins on the date of first occupancy of the dwelling or six months after the sale of the Product by an independent SCIL dealer/distributor, whichever occurs earlier. The warranty shall commence no later than 24 months following the date of product shipment from SCIL, regardless of the installation or occupancy date.

## EXCLUSIONS AND LIMITATIONS

This Limited Lifetime Warranty applies only if the Product is installed in the United States or Canada and only if used for the application for which it was designed and intended. The Product must be maintained in accordance with the printed instructions accompanying the Product and in compliance with all applicable installation and building codes and good trade practices.

This warranty is transferable. The Product must be purchased through a listed supplier of SCIL and proof of purchase must be provided. SCIL will be responsible for the replacement of the residential vent and/or chimney system considered to be defective for the following periods:

Termination Caps & Secure Black SW Stove Pipe – Replacement at no charge for 5 years from the date of installation, excluding labor

Components and fittings (excludes termination caps and Secure Black SW) –

Year 1-15 – Replacement of all components and fittings (a labor allowance may apply to a maximum of 300 \$ \* certain conditions apply).

Year 16 + – Replacement at 50% off of the prevailing list price in effect at the time of replacement (No labor allowance applies).

\*Labor Allowance Conditions: Any Warranty replacement work must be performed by a Professional Installer.

SCIL will not be responsible for: (a) damages caused by normal wear and tear, corrosion from salt air, accident, riot, fire, flood or acts of God; (b) damages caused by abuse, negligence, misuse, or unauthorized alteration or repair of the Product affecting its stability or performance. (The Product must be subject to normal use with approved fuels listed in the Operation Manual provided with the product. Where applicable, fuel products with abnormal burning characteristics, including but not limited to fuel such as driftwood, plywood and wood products using a binder may burn at excessive temperatures and may cause damage to the Product or may cause it to function improperly; (c) damages caused by failing to provide proper maintenance and service in accordance with the instructions provided with the Product; (d) damages, repairs or inefficiency resulting from faulty installation or application of the Product.

This Limited Lifetime Warranty covers only parts as provided herein. SCIL's entire liability is limited to the purchase price of this product. In no case shall SCIL be responsible for materials, components or construction which are not manufactured or supplied by SCIL or for the labor necessary to install, repair or remove such materials, components or construction. Additional utility bills incurred due to any malfunction or defect in equipment are not covered by this Limited Lifetime Warranty. All replacement or repair components will be shipped F.O.B. from the nearest stocking SCIL factory.

## LIMITATION ON LIABILITY

It is expressly agreed and understood that SCIL's sole obligation and the purchaser's exclusive remedy under this warranty, under any other warranty, expressed or implied, or in contract, tort or otherwise, shall be limited to replacement, repair, or refund, as specified herein.

In no event shall SCIL be liable for any incidental or consequential damages caused by defects in the Product, whether such damage occurs or is discovered before or after replacement or repair, and whether such damage is caused by SCIL's negligence. SCIL has not made and does not make any representation or warranty of fitness for a particular use or purpose, and there is no implied condition of fitness for a particular use or purpose. SCIL makes no expressed warranties except as stated in this Limited Lifetime Warranty. The duration of any implied warranty is limited to the duration of this expressed warranty.

No one is authorized to change this Limited Lifetime Warranty or to create for SCIL any other obligation or liability in connection with the Product. Some states and provinces do not allow the exclusion or limitation of incidental or consequential damages, so the above limitations or exclusions may not apply to you. The provisions of this Limited Lifetime Warranty are in addition to and not a modification of or subtraction from any statutory warranties and other rights and remedies provided by law.

## INVESTIGATION OF CLAIMS AGAINST WARRANTY

SCIL reserves the right to investigate any and all claims against this Limited Lifetime Warranty and to decide, in its sole discretion, upon the method of settlement.

To receive the benefits and advantages described in this Limited Lifetime Warranty, the appliance must be installed and repaired by a licensed contractor approved by SCIL. Contact SCIL at the address provided herein to obtain a listing of approved dealers/distributors. SCIL shall in no event be responsible for any warranty work done by a contractor that is not approved without first obtaining SCIL's prior written consent.

## HOW TO REGISTER A CLAIM AGAINST WARRANTY

In order for any claim under this warranty to be valid, you must contact the SCIL dealer/distributor from which you purchased the product. If you cannot locate the dealer/distributor, then you must notify SCIL in writing. SCIL must be notified of the claimed defect in writing within 90 days of the date of failure. Notices should be directed to the SCIL Warranty Department at 2125 Monterey Street, Laval, QC H7L 3T6.

[www.securitychimneys.com](http://www.securitychimneys.com)

**Security Chimneys**

2125 Monterey, Laval, Quebec  
Canada, H7L 3T6

450-973-9999  
800-361-4909 (US)  
800-667-3387 (Canada)  
450-973-2222 (Fax)

Need product information or technical support? Our customer service specialists are ready to answer your questions:

800-667-3387 or contact  
[infoeng@securitychimneys.com](mailto:infoeng@securitychimneys.com)



ESPV\_03-23-20

[www.securitychimneys.com](http://www.securitychimneys.com) 800-361-4909 (US) 800-667-3387 (Canada)

Security Chimneys International © 2014, 2018

Information published in all Security Chimneys literature is current at time of publication and is subject to change without notice.