



**ci**

**12 through 24 inch diameter  
Type-A Vent for  
Atmospheric Venting**



---

# Ci HIGH-RESISTANCE INDUSTRIAL CHIMNEY:

---

## Safety, Durability and Efficiency

For over 50 years, Security Chimneys has been an innovator in the venting field and a market leader in North America. Instrumental in the company's growth has been the introduction of new products and improvements to existing lines. This unrelenting quest for excellence has now given rise to the Ci insulated chimney, a high-quality product designed to deliver optimal performance. This new chimney system ensures outstanding venting while minimizing condensation.

---

### FIELD OF APPLICATION

The Ci chimney system is to be used with residential, commercial or industrial heating appliances powered by either liquid or gas fuels. Its sealing efficiency makes it suitable for negative appliances.

It has been tested by Warnock Hersey, according to UL-103 HT (Ø 305mm to 610mm / 12 to 24 inches) for use with masonry fireplaces (solid fuel appliances) USA only.

### DESIGN

Security Chimneys' Ci chimney is a stainless steel double-wall flue with thermal insulation provided by a mineral-fibre liner between its outer and inner walls. It has a mechanical locking seam.

### CONSTRUCTION

The external casing of the Ci chimney carries the structural load. The inner lining is free floating and attached only to the male coupler at the top, allowing it to expand and contract as flue gas temperatures change, therefore eliminating the need for special expansion joints.

### COMPOSITION

The Ci chimney system is available with:

- INNER CASING
- 304 / .024"
- OUTER CASING
- 430 / .018"
- Galvalume

### INSULATION

The Ci insulated chimney is lined with 2 inches of the highest quality insulation, densely packed to ensure low heat loss, maximum draft, minimal condensation and a 50mm (2 inches) close clearance to combustible materials.

For wood-burning fireplaces (Ø 305mm to 610mm / 12 to 24 inches) a 100mm (4 inch) clearance to combustible is required.

### INSTALLATION

The Ci-50 Ø 305 mm to 610 mm (12 to 24 inches) is assembled using a centering coupler system. Lengths and fittings slip-fit together, centering automatically with their extended 76 mm (3 inches) inner wall.

All Ci-50 insulated chimney lengths and fittings are delivered with a self-locking sealing band which must be installed on all joints to ensure gas tightness and sturdy assembly.

### WARNING

- For industrial application, not to be installed in a combustible chase.
- For residential application, can be enclosed with combustible materials at 50 mm (2 inches) clearance Ø 305 mm to 457 mm (12 to 18 inches) only.

---

# TECHNICAL SPECIFICATION

---

## TECHNICAL SUPPORT

Security Chimneys' Engineering Department is available to help you analyse your needs and make recommendations on your particular application.

## CERTIFICATION

THE **Ci** chimney system is listed as an Industrial chimney by Underwriters Laboratories ULC in Canada and UL in the United States to two standards. Also listed as a Type-A to standard UL-103 and ULC-S604 305 mm to 457 mm (12 to 18 inches) for residential and building heating appliances. It is also listed for venting wood-burning fireplaces by Warnock Hersey for diameters of 305 mm to 610 mm (12 to 24 inches)

Tested to:

ULC-S604	305 to 457 mm (12 to 18 inches)
ULC/ORD-C959	305 to 610 mm (12 to 24 inches)
UL-103	305 to 457 mm (12 to 18 inches)
UL-103 "Industrial"	305 to 610 mm (12 to 24 inches)
UL-103HT	305 to 610 mm (12 to 24 inches)

## Allowable flue gas temperature

Maximum Continuous	<u>Residential</u>	<u>Industrial</u>
	540°C (1000°F)	760°C (1400°F)
Brief force firing	<u>Residential</u>	<u>Industrial</u>
	760°C (1400°F)	927°C (1700°F)
Tested to:	1150°C (2100°F)	

## SPECIFICATION EXAMPLE

- 1.1 The pre-fabricated chimney, breeching and components shall be listed as an industrial chimney by ULC in Canada and by UL in the United States
- 1.2 It shall be listed for 760°C (1400°F) under continuous firing and 927°C (1700°F) in brief forced firing

## CONSTRUCTION

- 2.1 Each section must be made of two cylinders separated by 50mm (2 inches) of insulation for diameters 305 to 610 mm (12 to 24 inches)
- 2.2 The inner casing shall be made of 304 stainless steel, 0.60 mm (0.024 inch) thick. The outer casing must be made of 430 stainless steel, 0.45 mm (0.018 inch). The optional outer casing may be made of Galvalume steel, 0.45 mm (0.018 inch).
- 2.3 The seam must be double-folded mechanical locking type.
- 2.4 Coupling shall be provided to center the sections and to ensure proper spacing between the outer casing and flue pipe.
- 2.5 The insulating material shall possess a thermal conductivity factor of 0.034 W/m<sup>2</sup>K or less with output temperature of at least 1000°C (1832°F). Glass fiber insulation is not acceptable.
- 2.6 Each section shall allow the flue pipe to expand into the next section. For diameters 305 to 610 mm (12 to 24 inches), flue pipes shall overlap by at least 76 mm (2<sup>15/16</sup> inches)

## INSTALLATION

- 3.1 The installation shall be in accordance with the manufacturer's installation instructions.
- 3.2 All sections shall be held together by locking bands

---

## WARRANTY

Security Chimneys guarantees its **Ci** chimney for a period of 10 years from the date of purchase. This warranty is limited to the replacement of only the chimney lengths deemed defective, provided it has been properly installed and used as intended. The complete system must have been designed and sized by Security Chimneys' engineers who will base the sizing on the operating parameters provided by the customer. The entire chimney system, including breeching as required, must consist of **Ci** chimney components.

This warranty cannot be extended by our representatives. Warranty can be modified by our Engineering Department depending on the use of the Ci chimney.

# A NEW LINE OF FLUES FOR A NEW GENERATION OF HEATING APPLIANCES

In an effort to provide greater energy conservation, manufacturers have sought to design heating appliances offering a higher level of performance. In the process, conventional chimney flues have been rendered obsolete. Security Chimneys developed the **Ci** chimney in response to these changing needs. It is designed for easy installation in new construction.

## 1 > Coupler system for fast assembly

The Ci features an assembly system for fast and easy installation requiring no screws or other attachments

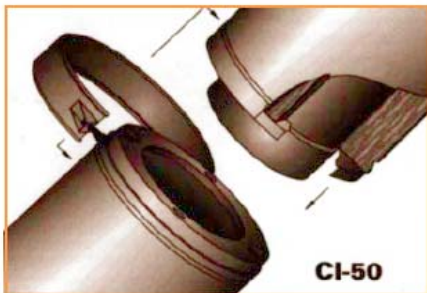

■ Ø 305 to 610 mm (12 to 24 in.): assembly with centering coupler with an extended inner wall + locking band. Overlap: 75 mm (2.94 in.)

## 2 > Stainless steel inner lining with low reaction to heat

- Inner lining for immediate heating
- Smooth surface: very slight heat loss to flue gases.
- Possible offset to 45°
- Outstanding corrosion resistance

## 3 > Densely-packed insulation of the highest quality

- No settling of the insulation
- Minimal cooling of flue gases which stabilize at high temperatures
- Absence of condensate and soot

## 4 > Stable, high-speed exhaust of flue gases

- Smaller flue diameter required
- Space savings
- Stable and powerful draft
- Easier and more accurate setting of the burner: reduced fuel consumption

## 5 > Outer casing

- Low surface temperature
- Minimum 50 mm (2 inch) safety clearance from combustible materials

## 6 > Inner lining unattached to female coupler

- Free-floating inner wall eliminates the need for expansion joints
- Unhindered expansion with rising temperatures
- 75 mm (3 inch) longer than outer casing for sturdy assembly

## 7 > Lightweight

- Ease of installation
- No support foundation required: a wall support is generally used





# INSTALLATION INFORMATION

## INSTALLATION

Assembly always requires the male coupler to be positioned upwards in the direction of the gas flow.

All lengths in the **CI** chimney system are effective lengths.

A locking band must always cover the joint where the lengths and fittings come together to ensure the tightness and sturdiness of the assembly.

No joint is to be positioned in the space between floors, ceilings and walls.

## SAFETY

Security Chimneys' insulated **CI** chimney can be installed as close as 50 mm (2 inches)\* from combustible materials. The installation of firestop spacers and radiation shields automatically maintains correct clearances as the chimneys pass through combustible floors or partitions.

\* The clearance is 100 mm (4 inches) for venting a masonry fireplace in diameters of 305 to 610 mm (12 to 24 inches)

## SUPPORT

Different types of supports are available to meet the requirements of various types of installations (see **LOADBEARING CAPACITY** table on next page)

- anchor plate
- floor support
- wall support
- adjustable wall support
- roof support
- suspension band

## STABILITY

### a) Chimney along a vertical surface

Wall bands ensure adequate clearance as well as the stability of the chimney. These are not loadbearing components.

They should be installed every 2.5 m (8 ft.) from any support in exterior installations, and 3 m (10 ft.) from supports in interior installations.

Also available is a wall band extension which is used in combination with a wall band to

extend the clearance between the chimney and wall surface by 50 mm to 135 mm (2 to 5.25 inches).

### b) Chimney section above the roof line:

No support is required for free standing chimneys extending up to 1.5 m (5 feet) beyond the roof line in areas with normal weather conditions.

#### \* Roof brace 1.5 to 3 m (5 to 9 feet):

In coastal areas or regions subject to high winds, the chimney should be stabilized using a roof brace. Angled telescopic legs allow the brace to adapt to any roof pitch.

On sloped roofs, it is used to stabilize chimneys between 1.5m and 3m (5 and 9 feet) beyond the roof.

#### \* Guy-wire band 1.50m to 4m (5 to 13 feet):

Beyond 1.50m (5 feet) from the last brace or support point, the chimney length can be stabilized using one guy-wire band every 1.50m (5 feet) to a maximum height of 4m (13 feet).

#### \* Wall band beyond 4m (13 feet):

Beyond 4m (13 feet), the chimney should be stabilized using wall bands attached to a metal structure or mast.

## ADJUSTMENT

To facilitate the installation of horizontal or diagonal sections, an insulated adjustable length is available. Regardless of the length of the adjustment, insulation must remain firmly packed inside the ring area.

## OFFSET

Elbows angled at 15°, 30° or 45° are available to offset the **CI** chimney used either vertically or horizontally. Vertically, a maximum offset of 45° is allowed.

## ASSEMBLY

The use of a 90° or 135° insulated tee makes it possible to laterally connect an appliance outlet to a vertical chimney. It is also suited to breach different appliances.

## CHIMNEY SIZING

A chimney flue must be well suited to installation requirements in terms of its geometric profile and combustion parameters. For more technical information, contact our Engineering Department.

## CONNECTION

Adaptors are needed to connect the chimney flue to the appliance.

We supply the most commonly used flue adaptors and flue extensions. For more information on adaptors see page 16 of this catalogue.

## WATERTIGHTNESS ON THE ROOF

Roof penetration by a **CI** chimney requires the installation of a roof flashing for weather protection.

Three types of flashings are available:

- flat roof flashing
- adjustable roof flashing: 5° to 30° pitch
- adjustable roof flashing: 30° to 45° pitch

Each flashing comes with a storm collar. To ensure waterproofing, the joint between the collar and chimney section must be sealed using a silicone caulking.

## TERMINATION

Several types of chimney termination caps are available and must be used at the top of the installation.

## WARNING

- \* Only use **CI** components
- \* Follow install instructions, failure to do so could void the certification and warranty.
- \* Access should be provided for inspection and cleaning of the chimney.
- \* Chimney should be cleaned at least once a year.
- \* Not to be enclosed in a combustible chase for industrial application.
- \* Contact local building or fire officials about applicable installation regulations.

# TECHNICAL DATA

## CI-50

Model	int. Ø mm (in.)	ext. Ø mm (in.)	insulation thickness mm (in.)	flue area cm <sup>2</sup> (in. <sup>2</sup> )	weight in kg (lb./ft.) per linear m.	twist-lock assembly	centering coupler system
CI 12	305 (12)	406 (16)	50 (2)	731 (113.3)	11.9 (8)		yes
CI 14	355 (14)	457 (18)	50 (2)	990 (153.4)	13.6 (9.2)		yes
CI 16	406 (16)	508 (20)	50 (2)	1295 (200.7)	15.3 (10.3)		yes
CI 18	457 (18)	559 (22)	50 (2)	1640 (254.2)	17.1 (11.6)		yes
CI 20	508 (20)	610 (24)	50 (2)	2027 (314.2)	19.1 (12.9)		yes
CI 22	559 (22)	660 (26)	50 (2)	2454 (380.4)	20.8 (15.2)		yes
CI 24	610 (24)	711 (28)	50 (2)	2923 (453)	22.6 (16.5)		yes

# LOADBEARING CAPACITY

## CI-50

### Maximum height

Diameter (mm) (in.)	305 12	355 14	406 16	457 18	508 20	559 22	610 24
<b>SUPPORT</b>							
Anchor plate (m) (ft.)	19 62	16.5 54	14.5 48	13 43	12 39	11 36	10 33
Floor support (m) (ft.)	15 49	13 43	11.5 38	10.5 34	9.5 31	8.5 28	8 26
Wall support point upward (m) (ft.)	16 52	14 46	12.5 41	11.5 38	10 33	9.5 31	8.5 28
point downward (m) (ft.)							
Roof support (m) (ft.)	10.5 34.4	9.5 31.2	8.5 27.9	7.5 24.6	6.5 21.4	6.0 19.7	5.5 18
Roof support,suspended (m) (ft.)							
Suspension band (m) (ft.)	1.8 6	1.8 6	1.8 6	1.8 6	1.8 6	1.8 6	1.8 6
<b>TEES</b>							
T 90(m) (ft.)	16 52	14 46	13 43	11 36	10 33	9 29	8 26
T 135(m) (ft.)	12 39	11 36	10 33	8 26	7 23	7 23	6 20

INCHES / FT.

METRIC

# TYPICAL INSTALLATIONS

**INTERIOR INSTALLATION OF CI FLUE TO A BASEMENT APPLIANCE.**

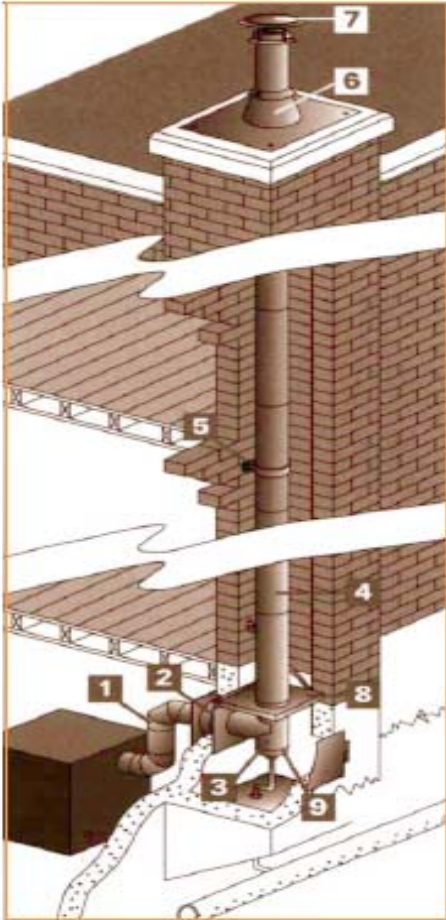

1. Connector
2. Wall radiation shield
3. 90° tee
4. Insulated length
5. Wall band
6. Flat roof flashing
7. Regular rain cap
8. Wall support
9. Insulated drain tee cap

**EXTERIOR INSTALLATION OF CI FLUE FOR VENTING A BOILER.**

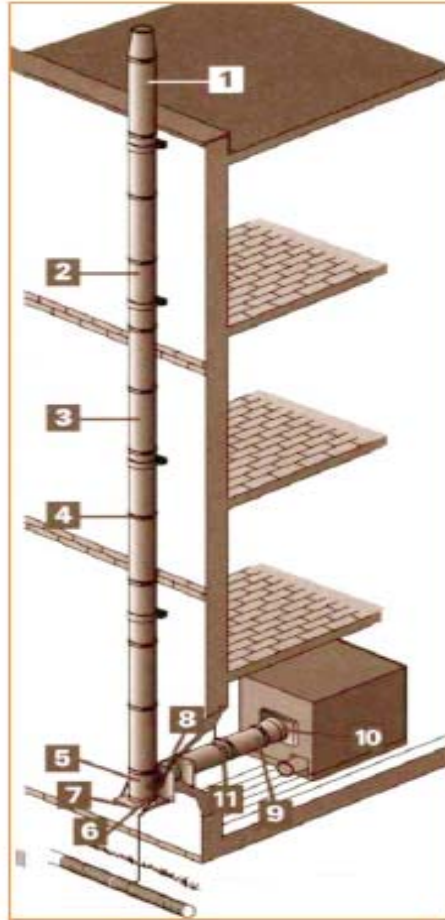

1. Finishing cone
2. Wall band
3. Insulated length
4. Locking band
5. 90° tee
6. Insulated drain tee cap
7. Wall support
8. Wall radiation shield
9. Insulated length (breeching)
10. Flue extension
11. Suspension band

**INTERIOR INSTALLATION OF CI FLUE THROUGH NON-COMBUSTIBLE FLOOR FOR VENTING A BOILER.**

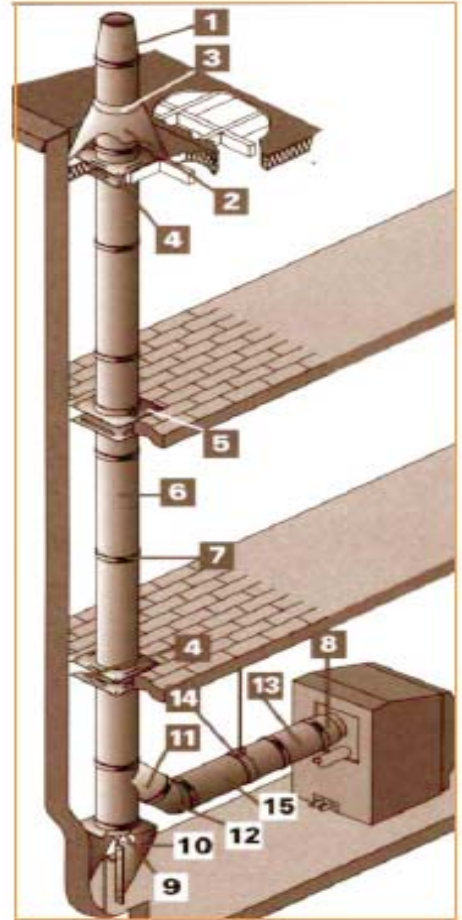

1. Finishing cone
2. Flat roof flashing
3. Storm collar
4. Firestop radiation shield
5. Floor support
6. Insulated length
7. Locking band
8. Increaser
9. Insulated drain tee cap
10. Wall support
11. 135° tee
12. 45° insulated elbow
13. Insulated length (breeching)
14. Suspension band
15. Adjustable length

## OFFSET CHART

For ease of dimensioning the assembly of a T135 and 45 elbow, please reference the chart below.

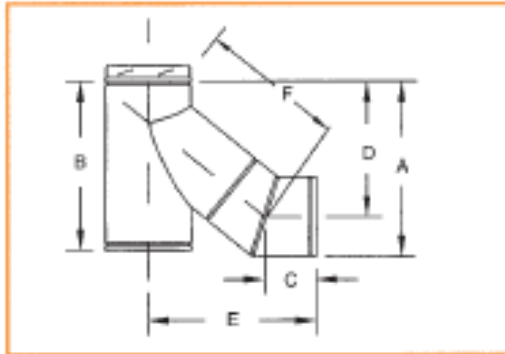

CI-50	Assembling a 135° tee and a 45° elbow						
INT. Ø (mm)	305	355	406	457	508	559	610
(inch)	12	14	16	18	20	22	24
EXT. Ø (mm)	406	457	508	559	610	661	712
(inch)	16	18	20	22	24	26	28
<b>A</b>	946	1050	1122	1225	1303	1403	1484
	37.2	41.3	44.2	48.2	51.3	55.2	58.4
<b>B</b>	810	860	899	975	1064	1102	1140
	31.9	33.8	35.4	38.4	41.9	43.4	44.9
<b>C</b>	188	188	213	213	213	274	274
	7.4	7.4	8.4	8.4	8.4	10.8	10.8
<b>D</b>	743	821	868	945	998	1072	1128
	29.2	32.3	34.2	37.2	39.3	42.2	44.4
<b>E</b>	720	787	849	915	961	1108	1152
	28.3	31	33.4	36	37.8	43.6	45.3
<b>F</b>	753	847	899	993	1058	1180	1242
	29.6	33.3	35.4	39	41.6	46.4	48.9

METRIC

INCHES / FT.



# LENGTHS

## INSULATED LENGTHS



Available in 7 diameters and 3 standard effective lengths of 290mm (12"), 440mm (18") and 900mm (36")

ALL LENGTHS ARE EFFECTIVE METRIC SIZES AFTER ASSEMBLY.

These components can be combined to meet the needs of any horizontal, diagonal or vertical installation. They come complete with a locking band which must properly cover each assembly joint.

Ref.: L	CI-50						
	Interior Ø (mm)	305	355	406	457	508	559
(inch)	12	14	16	18	20	22	24
Exterior Ø (mm)	406	457	508	559	610	660	711
(inch)	16	18	20	22	24	26	28
Insulation (mm)	50	50	50	50	50	50	50
(inch)	2	2	2	2	2	2	2
Weight (kg/m)	11.9	13.6	15.3	17.1	19.1	20.8	22.6
(lb/ft.)	8	9.2	10.3	11.6	12.9	15.2	17

Interior Ø (mm)	CI-50						
	Effective length (cm)	305	355	406	457	508	559
	-	-	-	-	-	-	-
	-	-	-	-	-	-	-
	-	-	-	-	-	-	-
	-	-	-	-	-	-	-
29	-	-	-	-	-	yes	yes
44	-	-	-	-	-	yes	yes
90	-	-	-	-	-	yes	yes



## ADJUSTABLE INSULATED LENGTH

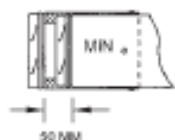
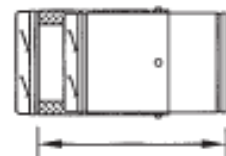
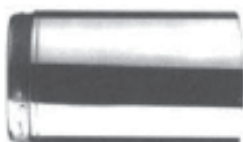

The extension for CI-50 varies from 50 to 240 mm (2 to 9 inches). This component must overlap the preceding one by at least 75 mm (3 inches). Self-taping screws lock the sections together, ensuring the sturdiness of the assembly.

The length comes with a locking band that must properly cover each assembly joint.

**IMPORTANT: The adjustable insulated length is not designed as a loadbearing component. Its vertical installation requires an appropriate support on the section above it to bear the weight of the remaining installation.**

Ref.: LA	CI-50						
	Interior Ø (mm)	305	355	406	457	508	559
(inch)	12	14	16	18	20	22	24
Minimum adjust.(mm)	50	50	50	50	50	50	50
(inch)	2	2	2	2	2	2	2
Maximum adjust.(mm)	240	240	240	240	240	240	240
(inch)	9	9	9	9	9	9	9

# TEES

## 90° TEE



Most often located at the base of a chimney, it makes it possible to connect the flue to the heating appliance. It can be installed at any horizontal or vertical point along the chimney to connect a length or ensure access for inspection or cleaning. May be used in breaching a chimney to allow installation of a draft damper. The 90° tee comes complete with an inspecting tee cap (TV). (Loadbearing capacity: see chart on page 6)

### Ref.: T90\*

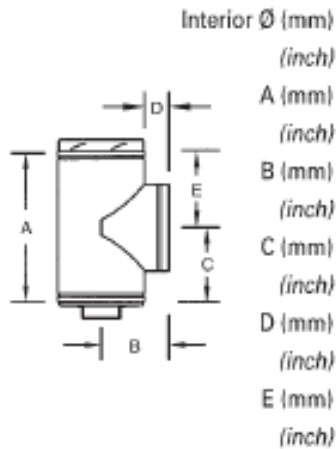

### CI-50

305	355	406	457	508	559	610
12	14	16	18	20	22	24
620	670	721	772	822	873	924
24.4	26.4	28.4	30.4	32.4	34.4	36.4
254	279	305	330	356	381	406
10	11	12	13	14	15	16
306	330	356	381	406	432	457
12	13	14	15	16	17	18
51	51	51	51	51	51	51
2	2	2	2	2	2	2
314	340	365	391	416	441	467
12.4	13.4	14.4	15.4	16.4	17.4	18.4

It performs the same function as the 90° tee, but is designed for diagonal connections that reduce heat loss and facilitate the upward flow of gases.

It is generally used in conjunction with a 45° elbow to permit the connection of a horizontal flue (for listing of assembly sizes, see chart on page 9). The 135° tee comes complete with an inspecting tee cap (TV).

(Loadbearing capacity: see chart on page 6)

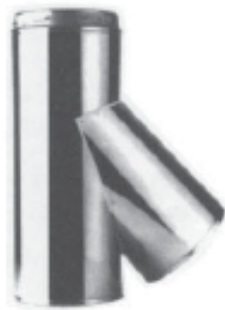

### Ref.: T135\*

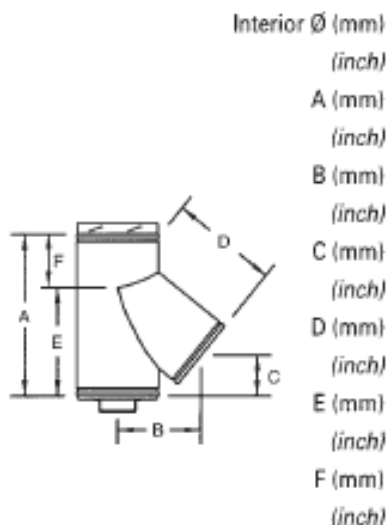

### CI-50

305	355	406	457	508	559	610
12	14	16	18	20	22	24
810	860	899	975	1064	1102	1140
31.9	33.8	35.3	38.4	41.9	43.4	44.9
400	466	485	552	598	640	684
15.7	18.3	19	21.7	23.5	25.2	27
199	172	182	180	216	224	206
7.8	6.8	7.2	7	8.5	8.8	8.1
565	659	686	780	845	906	968
22	26	27	30.7	33.2	35.7	38
599	638	667	732	814	864	890
23.6	25	26.2	28.8	32	34	35
211	222	232	243	250	238	250
8.3	8.7	9	9.5	9.8	9.4	9.8

#### \*Note:

Both the T90 and T135 are available with a smaller-sized throat (branch). In such case, dimensions remain the same except for inside and outside diameters of the throat (branch) section.

# TEES

## INSULATED TEE CAP



Designed to seal the base or lateral opening of a tee, it also prevents cooling of the gases.

It is removable, providing easy access for chimney maintenance or inspection.

Ref.: TI

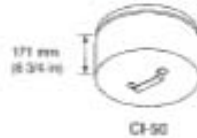

## INSULATED DRAIN TEE CAP



This component is fitted at the base of a tee installed vertically. It makes it possible to collect and drain rain water and condensates.

Removable, it provides easy access for chimney maintenance or inspection. Threaded nipple (Ø 1 in.-11½ NPT)

Ref.: TPI

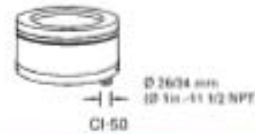

## LOCKING BAND



It is imperative that a locking band be fitted over each assembly joint to ensure the tightness of the joint and the sturdiness of the assembly.

Featuring a ceramic felt gasket, the band positions itself around the section at the joint.

Made of stainless steel, it automatically comes with all chimney components except the roof terminations.

Ref.: BS

Interior Ø (mm)  
(inch)  
A (mm)  
(inch)

CI-50

305	355	406	457	508	559	610
12	14	16	18	20	22	24
40	40	40	40	40	40	40
1.6	1.6	1.6	1.6	1.6	1.6	1.6



# ELBOWS

## 15° INSULATED ELBOW



Allows the 15° offset of a horizontal or vertical section.

It can be used in combination with other elbows to form offsets at specific angles (no attachment notches in the female coupler) or to deviate the chimney.

It comes complete with a locking band.

### Ref.: D15

Interior Ø (mm)

(inch)

Exterior Ø (mm)

(inch)

A Offset (mm)

(inch)

B (mm)

(inch)

C (mm)

(inch)

D (mm)

(inch)

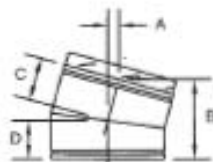

### CI-50

305	355	406	457	508	559	610
12	14	16	18	20	22	24
406	457	508	559	610	661	712
16	18	20	22	24	26	28
36	36	36	36	45	45	49
1.4	1.4	1.4	1.4	1.8	1.8	1.9
272	272	272	272	343	343	368
10.7	10.7	10.7	10.7	13.5	13.5	14.5
138	138	138	138	175	175	187
5.4	5.4	5.4	5.4	6.9	6.9	7.4
138	138	138	138	175	175	187
5.4	5.4	5.4	5.4	6.9	6.9	7.4

Allows the 30° offset of a horizontal or vertical section.

It can be used in combination with other elbows to form offsets at specific angles (no attachment notches in the female coupler) or to deviate the chimney.

It comes complete with a locking band.



### Ref.: D30

Interior Ø (mm)

(inch)

Exterior Ø (mm)

(inch)

A (mm)

(inch)

B (mm)

(inch)

C (mm)

(inch)

D (mm)

(inch)

E (mm)

(inch)

F (mm)

(inch)

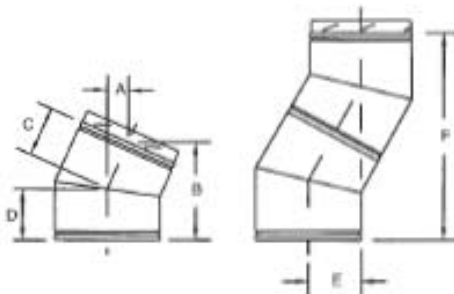

### CI-50

305	355	406	457	508	559	610
12	14	16	18	20	22	24
406	457	508	559	610	661	712
16	18	20	22	24	26	28
94	94	106	106	106	136	136
3.7	3.7	4.2	4.2	4.2	5.3	5.3
340	340	400	400	400	475	475
13.4	13.4	15.8	15.8	15.8	18.7	18.7
187	187	213	213	213	270	270
7.4	7.4	8.4	8.4	8.4	10.6	10.6
178	178	216	216	216	241	241
7	7	8.5	8.5	8.5	9.5	9.5
187	187	213	213	213	270	270
7.4	7.4	8.4	8.4	8.4	10.6	10.6
680	690	800	800	800	950	950
26.8	26.8	31.5	31.5	31.5	37.4	37.4



## ELBOWS

### 45° INSULATED ELBOW



Allows the 45° offset of a horizontal or vertical section.

It can be used in combination with other elbows to form offsets at specific angles (no attachment notches in the female coupler) or to deviate the chimney. It comes complete with a locking band.

#### Ref.: D45

Interior Ø (mm)

(inch)

Exterior Ø (mm)

(inch)

A (mm)

(inch)

B (mm)

(inch)

C (mm)

(inch)

D (mm)

(inch)

E (mm)

(inch)

F (mm)

(inch)

G (mm)

(inch)

H (mm)

(inch)

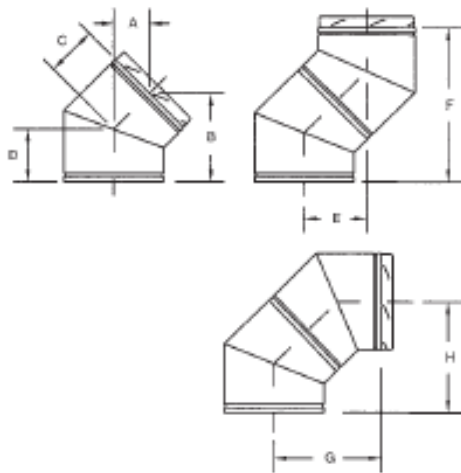

#### CI-50

305	355	406	457	508	559	610
12	14	16	18	20	22	24
406	457	508	559	610	661	712
16	18	20	22	24	26	28
132	132	150	150	150	194	194
5.2	5.2	5.9	5.9	5.9	7.6	7.6
320	320	363	363	363	468	468
12.6	12.6	14.3	14.3	14.3	18.4	18.4
188	188	213	213	213	274	274
7.4	7.4	8.4	8.4	8.4	10.8	10.8
188	188	213	213	213	274	274
7.4	7.4	8.4	8.4	8.4	10.8	10.8
264	264	300	300	300	388	388
10.4	10.4	11.8	11.8	11.8	15.3	15.3
640	640	726	726	726	935	935
25.2	25.2	28.6	28.6	28.6	36.8	36.8
452	452	513	513	513	662	662
17.8	17.8	20.2	20.2	20.2	26	26
452	452	513	513	513	662	662
17.8	17.8	20.2	20.2	20.2	26	26

## SUPPORTS

### ANCHOR PLATE



It is sealed to the lintel of a masonry chimney or provides a positive connection between the chimney and a boiler. It receives and supports the first section of the assembled chimney. (See loadbearing chart on page 6) Made of galvanized steel.

#### Ref.: SA

Interior Ø (mm)

(inch)

A (mm)

(inch)

B (mm)

(inch)

C (mm)

(inch)

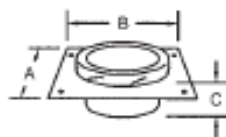

#### CI-50

305	355	406	457	508	559	610
12	14	16	18	20	22	24
432	483	533	584	635	686	737
17	19	21	23	25	27	29
432	483	533	584	635	686	737
17	19	21	23	25	27	29
22	22	22	22	22	22	22
.9	.9	.9	.9	.9	.9	.9

# SUPPORTS

## WALL SUPPORT



Supports the chimney at the base of the installation, or along a wall or other vertical surface serving as an intermediate support. This support is attached to the wall structure. It comes with a tightening collar locked around the chimney and secured by self-taping screws (supplied). The collar rests on the horizontal plate. When used as a base support, it lends itself to the addition of an insulated tee-cap or drain tee-cap. Available in galvanized steel (SMIF) or stainless steel (SMIC).

Ref.: SMI

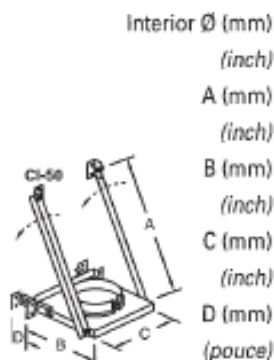

CI-50

Interior Ø (mm)	305	355	406	457	508	559	610
(inch)	12	14	16	18	20	22	24
A (mm)	889	889	889	1016	1016	1219	1219
(inch)	35	35	35	40	40	48	48
B (mm)	610	610	610	710	710	810	810
(inch)	24	24	24	28	28	32	32
C (mm)	560	560	560	660	660	760	760
(inch)	22	22	22	26	26	30	30
D (mm)	← 0 to 125 mm. →						
(pouce)	← 0 to 5 inches →						

Complementary support usually attached to a roof structure.

Two adjustable plates screwed to the structure adapt to the pitch of the roof. A tightening collar attached to these two plates locks around the flue and is secured by self-taping screws (supplied). (See loadbearing chart on page 6) Made of galvalume steel.



Ref.: ST/STHT\*

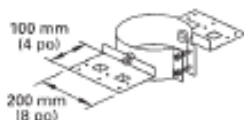

Supports the flue on a slab, floor or joist. Provides a minimum 50 mm (2-inch) clearance between the outer casing of the chimney and combustible materials around it.

A tightening collar, locked around the flue and secured to the chimney by self-taping screws (supplied), rests on a horizontal plate screwed or nailed to the floor. (See loadbearing chart on page 6) Made of galvanized steel. Can be used with a firestop spacer attached beneath the ceiling, making it possible to position the chimney and seal the space around the opening.



Ref.: SD

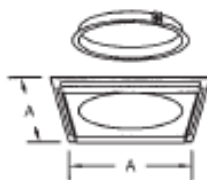

CI-50

Interior Ø (mm)	305	355	406	457	508	559	610
(inch)	12	14	16	18	20	22	24
A (mm)	560	610	610	710	760	810	860
(inch)	22	24	24	28	30	32	34

# ADAPTORS

## FLUE EXTENSION

This cylindrical component is designed to connect the **CI** chimney to an outlet having an identical  $\varnothing$ , or to a tapered adapting sleeve made by the installer.

The crimped end is slightly tapered for ease of assembly.

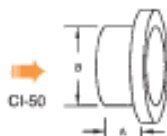

Ref.: **RS**

Interior  $\varnothing$  (mm)

(inch)

A (mm)

(inch)

B (mm)

(inch)

**CI-50**

305	355	406	457	508	559	610
-----	-----	-----	-----	-----	-----	-----

12	14	16	18	20	22	24
----	----	----	----	----	----	----

85	85	85	85	85	85	85
----	----	----	----	----	----	----

3.4	3.4	3.4	3.4	3.4	3.4	3.4
-----	-----	-----	-----	-----	-----	-----

310	360	411	462	513	564	615
-----	-----	-----	-----	-----	-----	-----

12.2	14.2	16.2	18.2	20.2	22.2	24.2
------	------	------	------	------	------	------

Note: The flue extension on the CI-50 is incorporated in every length.

## REDUCER / INCREASER

It is designed with a tapered shape to connect the **CI** chimney to an outlet one or two sizes greater or smaller.

Example: To order a reducer 16 in. to 14 in. → CI16 RI14.

To order an increaser 16 in. to 20 in. → CI16 RI20



Ref.: **RI**



**1 step 2 step**

C (mm)	187	238
(inch)	7.4	9.4

## STEP INCREASER

The step increaser is needed for differences of more than two steps in size are required.

Example: To order a step increaser 12 in. to 16 in. > CI12 SI16



Ref.: **SI**

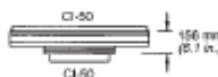

Note: Adaptors can be customized to your requirements. Contact the Engineering Department for assistance.

## ADAPTOR CI/CT

This adaptor is designed to connect the **CI** chimney to a **CT** chimney having an identical  $\varnothing$ .

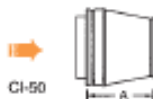

Ref.: **RCT**

Interior  $\varnothing$  (mm)

(inch)

A (mm)

(inch)

**CI-50**

305	355	406	457	508	559	610
-----	-----	-----	-----	-----	-----	-----

12	14	16	18	20	22	24
----	----	----	----	----	----	----

313	313	313	313	313	313	313
-----	-----	-----	-----	-----	-----	-----

12.3	12.3	12.3	12.3	12.3	12.3	12.3
------	------	------	------	------	------	------

## ADAPTOR CT/CI

This adaptor is designed to connect the **CT** chimney to a **CI** chimney having an identical  $\varnothing$ .

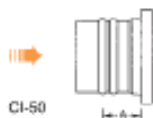

Ref.: **CT  $\varnothing$  RCI**

Interior  $\varnothing$  (mm)

(inch)

A (mm)

(inch)

**CI-50**

305	355	406	457	508	559	610
-----	-----	-----	-----	-----	-----	-----

12	14	16	18	20	22	24
----	----	----	----	----	----	----

114	114	114	114	114	114	114
-----	-----	-----	-----	-----	-----	-----

4.5	4.5	4.5	4.5	4.5	4.5	4.5
-----	-----	-----	-----	-----	-----	-----

Direction of flow

# FIRESTOPS

## RADIATION SHIELD

Protects combustible materials when the chimney passes through a floor, ceiling or an attic.

The radiation shield ensures a 50 mm (2-inch) safety clearance between the outer casing of the flue and surrounding materials.

No insulation should be inserted between the outer casing of the chimney and the interior surface of the radiation shield. Made of galvalume steel.

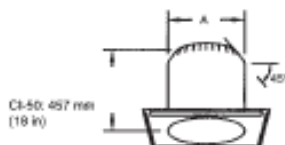

Ref.: FP/FPHT\*

CI-50

Interior Ø (mm)  
(inch)  
A (mm)  
(inch)

305	355	406	457	508	559	610
12	14	16	18	20	22	24
508	559	610	660	711	762	813
20	22	24	26	28	30	32

\* FPHT for UL-103 HT application on masonry fireplace only. Ensures a 100 mm (4-inch) clearance to combustibles.

## WALL RADIATION SHIELD

Protects combustible materials when the chimney passes through a horizontal opening.

A decorative plate painted in matte black provides an interior finish. Supplied only in sizes of 152, 178, 203 and 254 mm (6, 7, 8 and 10 inches). The shield ensures a 50 mm (2-inch) safety clearance between the outer casing of the flue and surrounding materials. Adjustable to adapt to the thickness of the wall. Made of galvalume steel.

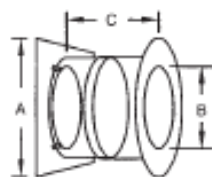

Ref.: FM

CI-50

Interior Ø (mm)  
(inch)  
A (mm)  
(inch)  
B (mm)  
(inch)  
C min. (mm)  
(inch)  
C max. (mm)  
(inch)

305*	355*	406*	457*	508*	559*	610*
12	14	16	18	20	22	24
560	610	660	710	760	810	860
21.8	23.8	25.7	27.7	29.6	31.6	33.5
406	457	508	559	610	660	711
16	18	20	22	24	26	28
200	200	200	200	200	200	200
7.8	7.8	7.8	7.8	7.8	7.8	7.8
307	307	307	307	307	307	307
12.1	12.1	12.1	12.1	12.1	12.1	12.1

\*Not UL / ULC listed.

## FIRESTOP RADIATION SHIELD

Attached on and/or under a floor or on both sides of a partition (CI-50), it serves to position the chimney whenever it passes through a floor, slab or joist, maintaining a minimum 50 mm (2-inch) clearance between the external casing of the flue and surrounding combustible materials. No section joint must be in the ceiling/floor space. Made of galvalume steel.



Ref.: FEA

CI-50

Interior Ø (mm)  
(inch)  
A (mm)  
(inch)

305	355	406	457	508	559	610
12	14	16	18	20	22	24
560	610	660	710	760	810	860
22	24	26	28	30	32	34

Ref.: FEAHT\*

CI-50

Ø Interior (mm)  
(inch)  
A (mm)  
(inch)

305	355	406	457	508	559	610
12	14	16	18	20	22	24
710	760	810	860	910	960	1010
28	30	32	34	36	38	40

\*FEAHT for UL-103HT application on masonry fireplace only. Ensures a 100 mm (4-inch) clearance to combustibles.



# STABILIZING BANDS

## WALL BAND

Designed for interior or exterior use, this band stabilizes the chimney along a vertical or diagonal surface: wall, mast, partition, joist...

The band also ensures a minimum clearance of 50 mm (2 inches) between the outer casing of the chimney and the surface to which it is attached. A greater clearance requires the use of a wall band extension. Wall bands should be installed every 2.5 m (8 ft.) from any support in exterior installations, and 3 m (10 ft.) from supports in interior installations.

Exterior use: band and attachment made of 304 stainless steel (BMC).

Interior use: band made of galvalume steel and attachment made of galvanized steel (BMEF).

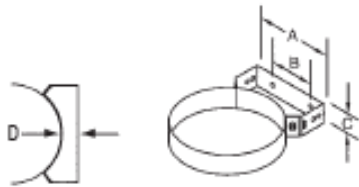

Ref.: BM

Interior Ø (mm)

(inch)

A (mm)

(inch)

B (mm)

(inch)

C (mm)

(inch)

D (mm)

(inch)

CI-50

305	355	406	457	508	559	610
-----	-----	-----	-----	-----	-----	-----

12	14	16	18	20	22	24
----	----	----	----	----	----	----

323	358	396	432	467	503	538
-----	-----	-----	-----	-----	-----	-----

12.7	14.1	15.6	17	18.4	19.8	21.2
------	------	------	----	------	------	------

274	310	348	384	419	455	490
-----	-----	-----	-----	-----	-----	-----

10.8	12.2	13.7	15.1	16.5	17.9	19.3
------	------	------	------	------	------	------

50	50	50	50	50	50	50
----	----	----	----	----	----	----

2	2	2	2	2	2	2
---	---	---	---	---	---	---

50	50	50	50	50	50	50
----	----	----	----	----	----	----

2	2	2	2	2	2	2
---	---	---	---	---	---	---

## WALL BAND EXTENSION

Attached to the wall band, it is designed to extend the clearance between the chimney and wall surface by 50 mm to 85 mm (2 to 3.25 inches). A bolt and slot configuration allow the adjustment. **Should always be used in UL-103HT application on masonry fireplace.**

Keeps the outer casing of the flue 100 mm to 135 mm (4 to 5.25 inches) from the wall surface. Made of stainless steel BEC (exterior use) or galvanized steel BEF (interior use).

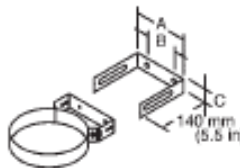

Ref.: BE

Interior Ø (mm)

(inch)

A (mm)

(inch)

B (mm)

(inch)

C (mm)

(inch)

CI-50

305	355	406	457	508	559	610
-----	-----	-----	-----	-----	-----	-----

12	14	16	18	20	22	24
----	----	----	----	----	----	----

328	363	401	437	472	508	544
-----	-----	-----	-----	-----	-----	-----

12.9	14.3	15.8	17.2	18.6	20	21.4
------	------	------	------	------	----	------

274	310	348	384	419	455	490
-----	-----	-----	-----	-----	-----	-----

10.8	12.2	13.7	15.1	16.5	17.9	19.3
------	------	------	------	------	------	------

50	50	50	50	50	50	50
----	----	----	----	----	----	----

2	2	2	2	2	2	2
---	---	---	---	---	---	---

## STABILIZING BANDS

### SUSPENSION BAND



Stabilizes and supports the **CI** chimney section used in a horizontal application. Makes it possible to suspend **CI** chimney sections using a threaded rod attach to the ceiling of the boiler room or any point. This support is needed every 2.00 m (6.6 ft) or **CI-50** flue). Made of stainless steel (BDSC). Also available in galvalume (BDSE).

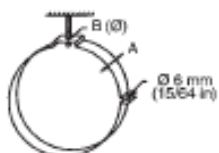

Ref.: BDS

Interior Ø (mm)

(inch)

A (mm)

(inch)

B (mm)

(inch)

CI-50

305	355	406	457	508	559	610
12	14	16	18	20	22	24
50	50	50	50	50	50	50
2	2	2	2	2	2	2
12	12	12	12	12	12	12
15/32	15/32	15/32	15/32	15/32	15/32	15/32

### GUY WIRE BAND



Attached to the outer casing of the chimney, it is designed to hold 3 guy wires at a 120-degree angle to stabilize a **CI** chimney section extending from 1.5 metres (5 ft.) to 4 metres (13 ft.) beyond the last rooftop support (guy wires not included). Use three 5 mm (3/16 inch) guy wires, 120 degrees apart.

Made of stainless steel.

Ref.: BH

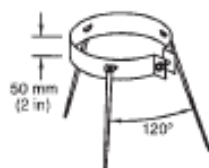

### ROOF BRACE



This component comes complete with tightening collar and adjustable legs.

Used to stabilize the **CI** chimney section extending beyond the roof in areas subjected to high winds or lengths extending 1.5 m to 3 m (5 to 10 ft.) from the last support or attachment point. \* The legs are adjustable from 850 mm to 1500 mm (33 to 60 inches)

Made of galvalume steel.

Ref.: BT

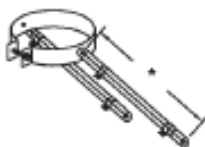

# ROOF FLASHINGS

## STORM COLLAR

Designed to fit over flashings of any kind, it ensures a watertight seal between the chimney's external casing and the flashing. The storm collar must be sealed with silicone caulking. Provided with all roof flashings.



Ref.: EC

Interior Ø (mm)

(inch)

A (mm)

(inch)

B (mm)

(inch)

C (mm)

(inch)

CI-50

305	355	406	457	508	559	610
12	14	16	18	20	22	24
114	114	114	114	114	114	114
4.5	4.5	4.5	4.5	4.5	4.5	4.5
123	123	123	123	123	123	123
4.8	4.8	4.8	4.8	4.8	4.8	4.8
46	46	46	46	46	46	46
1.8	1.8	1.8	1.8	1.8	1.8	1.8

## FLAT ROOF FLASHING

This component seals a chimney length extending from a flat or very slightly sloped (no more than 5° pitch) roof.

The roof plate, the flashing cone and the storm collar are made of galvalume steel.

It comes complete with a storm collar. The storm collar must be sealed with silicone caulking.

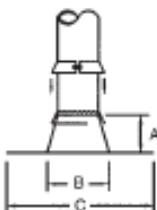

Ref.: EP

Interior Ø (mm)

(inch)

A (mm)

(inch)

B (mm)

(inch)

C (mm)

(inch)

CI-50

305	355	406	457	508	559	610
12	14	16	18	20	22	24
279	279	279	279	279	279	279
11	11	11	11	11	11	11
508	559	610	660	771	762	813
20	22	24	26	28	30	32
914	1016	1016	1067	1067	1067	1067
36	40	40	42	48	48	48

## ADJUSTABLE ROOF FLASHING 5° TO 30°

This component seals a chimney length extending from a roof with a 5° to 30° pitch.

The roof plate is made of galvalume or aluminum while the flashing cone and the storm collar are made of galvalume steel.

It comes complete with a storm collar. The storm collar must be sealed with silicone caulking.

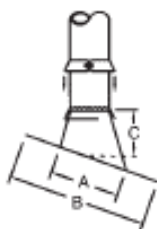

Ref.: E30

Interior Ø (mm)

(inch)

A (mm)

(inch)

B (mm)

(inch)

C (mm)

(inch)

CI-50

305	355	406	457	508	559	610
12	14	16	18	20	22	24
594	655	711	772	833	889	950
23.4	25.8	28	30.4	32.8	35	37.5
1016	1067	1067	1270	1168	1346	1473
40	42	42	50	46	53	58
238	246	254	262	270	278	286
9.4	9.7	10	10.3	10.6	10.9	11.2

## ROOF FLASHING

### ADJUSTABLE ROOF FLASHING 30° TO 45°



This component seals a chimney length extending from a roof with a 30° to 45° pitch.

The roof plate is made of galvalume or aluminum while the flashing cone and the storm collar are made of galvalume steel.

It comes complete with a storm collar. The storm collar must be sealed with silicone caulking.

Ref.: E45

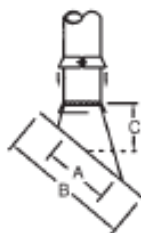

Interior Ø (mm)

(inch)

A (mm)

(inch)

B (mm)

(inch)

C (mm)

(inch)

CI-50

305	355	406	457	508	559	610
12	14	16	18	20	22	24
744	823	899	978	1057	1133	1212
29.3	32.4	35.4	38.5	41.6	44.6	47.7
1219	1168	1321	1219	1219	1346	1524
48	46	52	48	48	53	60
395	414	434	453	473	492	512
15.5	16.3	17	17.8	18.6	19.4	20.1

## TERMINATION CAPS

A number of termination caps are available with CI chimney system. The purpose of a termination cap is to protect a male coupler and protect the chimney opening from rain, snow and leaves. It also provides an attractive finishing element.

### FINISHING CONE



This finishing cone is secured to the last length of the chimney by centering coupler + locking band (NOT SUPPLIED)

The interior wall is flush with the inner lining of the chimney length, therefore producing a better draft: only the outer casing is cone-shaped. When the chimney system is terminated with a finishing cone, an insulated drain tee cap must be installed.

Ref.: CF



Interior Ø (mm)

(inch)

A (mm)

(inch)

B (mm)

(inch)

CI-50

305	355	406	457	508	559	610
12	14	16	18	20	22	24
323	323	323	323	323	323	323
12.7	12.7	12.7	12.7	12.7	12.7	12.7
305	355	406	457	508	559	610
12	14	16	18	20	22	24



# TERMINATION CAPS

## SHORT TERMINATION



The short termination cap is secured to the last length of the chimney by a centering coupler + locking band (not supplied) available for **CI-50**. When the chimney system is terminated with a short termination, an insulated drain tee cap must be installed.

Ref.: CR



CI-50

	305	355	406	457	508	559	610
Interior Ø (mm)	305	355	406	457	508	559	610
(inch)	12	14	16	18	20	22	24
A (mm)	406	457	508	559	610	660	711
(inch)	16	18	20	22	24	26	28
B (mm)	152	152	152	152	152	152	152
(inch)	6	6	6	6	6	6	6

## REGULAR RAIN CAP

The regular rain cap is secured to the last length of the chimney by twist-lock assembly (**CI-25**) or centering coupler (**CI-50**) + locking band (not supplied). The CU2 rain cap comes with a spark arrester for Ø 305 to 457 mm (12 to 18 inches).

CI-50

Interior Ø (mm)  
(inch)  
A (mm)  
(inch)  
B (mm)  
(inch)  
C (mm)  
(inch)

	305	355	406	457	508*	559*	610*
Interior Ø (mm)	305	355	406	457	508*	559*	610*
(inch)	12	14	16	18	20	22	24
A (mm)	127	127	127	127	125	125	125
(inch)	5	5	5	5	4.8	4.8	4.8
B (mm)	267	267	267	267	425	425	425
(inch)	10.5	10.5	10.5	10.5	16.5	16.5	16.5
C (mm)	737	737	838	838	890	940	990
(inch)	29	29	33	33	34.7	36.6	38.6

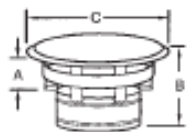

Ref.: CU 1  
Ø 305 à 457 mm  
(Ø 12 in. à 18 in.)

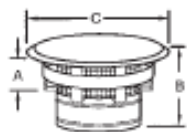

Ref.: CU 2  
Ø 305 à 457 mm  
(Ø 12 in. à 18 in.)

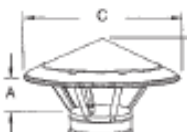

Ref.: CU  
Ø 508 à 610 mm  
(Ø 20 in. à 24 in.)



---

**Established in Canada for over 30 years, Security Chimneys is a North American leader in the production of factory-built venting systems and fireplaces.**

**The line of products manufactured and marketed by the Security Chimneys Division includes:**

---

### **ASHT +**

- For use with efficient solid fuel appliances (wood and coal) in HT applications.
  - Listed to UL-103HT standards, High Temperature and ULC-S610 for fireplaces.
  - Available in diameters of 152 to 254 mm (6 to 10 in.)
  
  - Also approved to vent heating appliances (gas or oil)
  - Listed to UL-103, Type A and ULC-S604 standards.
  - Available in diameters of 152 to 457 mm (6 to 18 in.)
- 

### **S-2100 +**

- For use with efficient solid fuel appliances.
  - Listed to ULC-S629M standard.
  - Available in diameters of 152 mm, 178 mm, and 203 mm (6, 7 and 8 in.)
- 

### **CG**

- Compatible with all gas appliances.
  - Listed to UL-605 and UL-441 standards.
  - Available in diameters of 76 to 914 mm (3 to 36 in.)
- 

### **CT**

- For use in vertical tubing for masonry chimneys.
  - For independent use on high efficiency gas boilers with condensation, in vertical and/or horizontal, interior or exterior installations.
  - Certified to ULC and UL standards (in process).
  - Available in diameters of 127 to 610 mm (5 to 24 in.)
- 

### **TUBINOX**

- To reline an existing masonry chimney, or to substitute the clay liner in a new masonry chimney.
  - Listed to ULC-S635M, UL-1777 and ULC-S640M standards.
  - Available in diameters of 127 to 203 mm (5 to 8 in.)
- 

---

**Distributed by:**

